



Installation instructions, accessories

Volvo Car Corporation Gothenburg, Sweden

Instruction No	Version	Part. No.
31408213	1.0	31373092

Parking assistance, front



Installation instructions, accessories

Volvo Car Corporation Gothenburg, Sweden

Materials

Designation	Part number
Electrical tape	

Equipment

VIDA

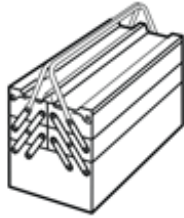

IMG-242205

A0000162

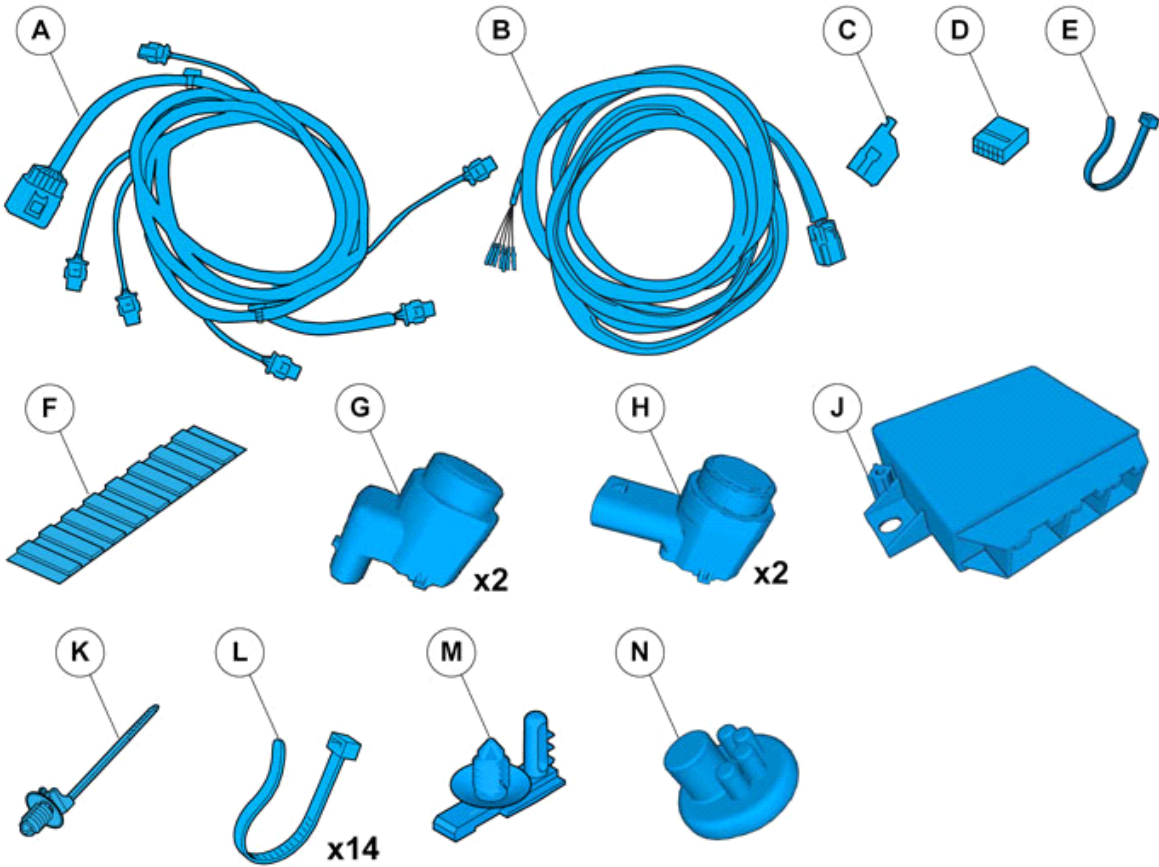

IMG-378025



Installation instructions, accessories

Volvo Car Corporation Gothenburg, Sweden

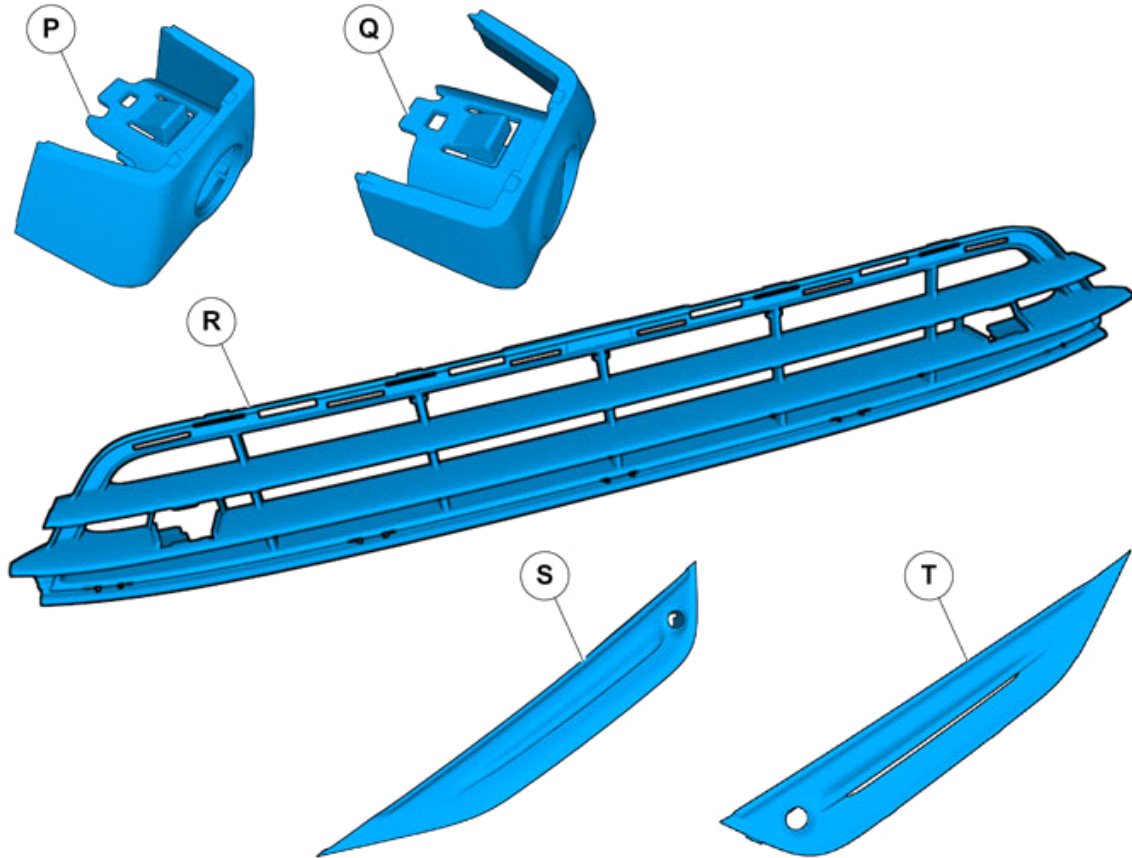

IMG-378261



Installation instructions, accessories

Volvo Car Corporation Gothenburg, Sweden

36630-2

Parking assistance, front, R-design

Information

1

Read through all of the instructions before starting installation.

Notifications and warning texts are for your safety and to minimise the risk of something breaking during installation.

Ensure that all tools stated in the instructions are available before starting installation.

Certain steps in the instructions are only presented in the form of images. Explanatory text is also given for more complicated steps.

In the event of any problems with the instructions or the accessory, contact your local Volvo dealer.

Further information

2

These installation instructions show installation on left hand drive cars.

When installing on right-hand drive cars, perform the procedures on the opposite side and/or mirrored.

Where the procedure differs, the right-hand version is also shown with text and image.

Color symbols



Installation instructions, accessories

Volvo Car Corporation Gothenburg, Sweden

3

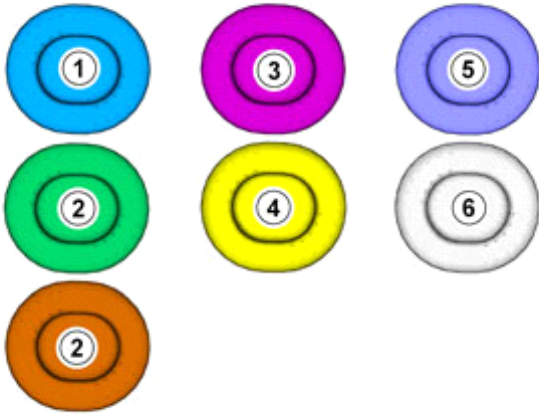

IMG-363036

Note!

This colour chart displays (in colour print and electronic version) the importance of the different colours used in the images of the method steps.

1. Used for focused component, the component with which you will do something.
2. Used as extra colors when you need to show or differentiate additional parts.
3. Used for attachments that are to be removed/installed. May be screws, clips, connectors, etc.
4. Used when the component is not fully removed from the vehicle but only hung to the side.
5. Used for standard tools and special tools.
6. Used as background color for vehicle components.

Removal

4

Set the ignition key to position 0.



IMG-332193



Installation instructions, accessories

Volvo Car Corporation Gothenburg, Sweden

5

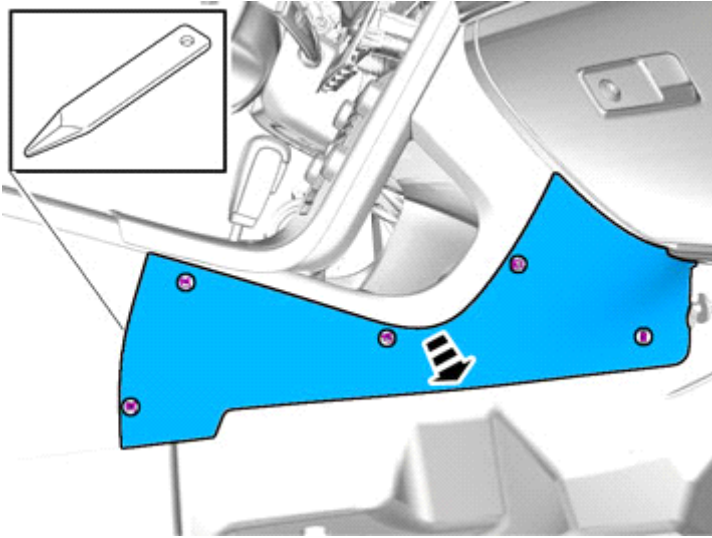

IMG-340600

Remove the panel.

6

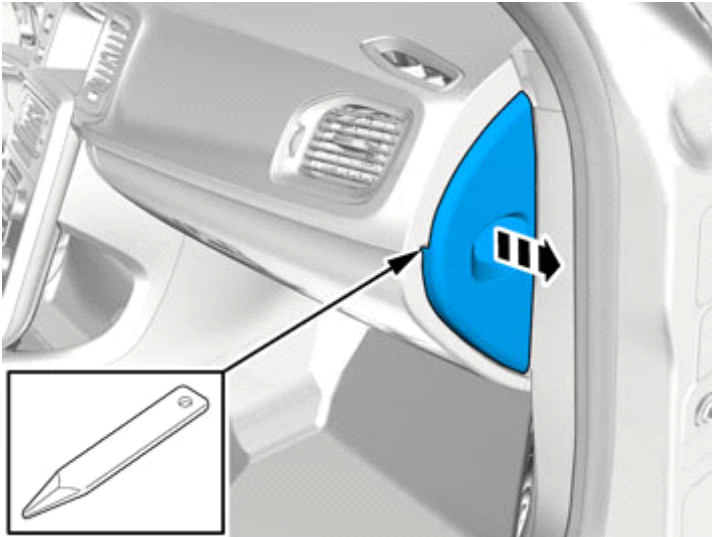

IMG-344926

7

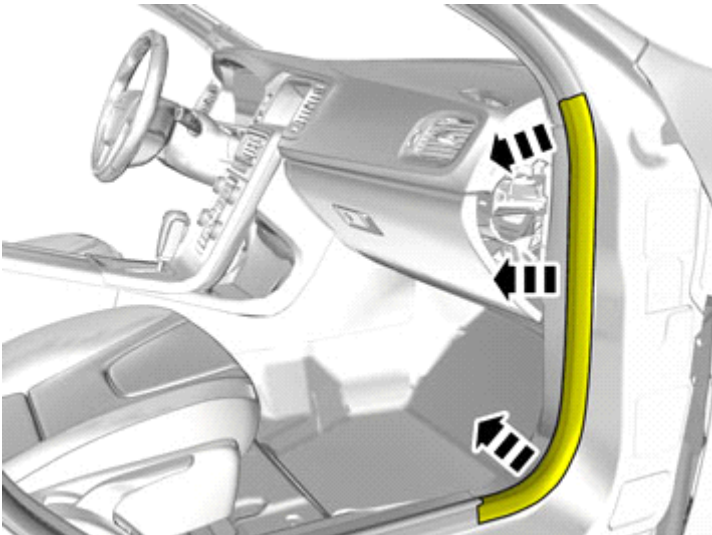

IMG-344927

Remove the weatherstrip.



Installation instructions, accessories

Volvo Car Corporation Gothenburg, Sweden

8

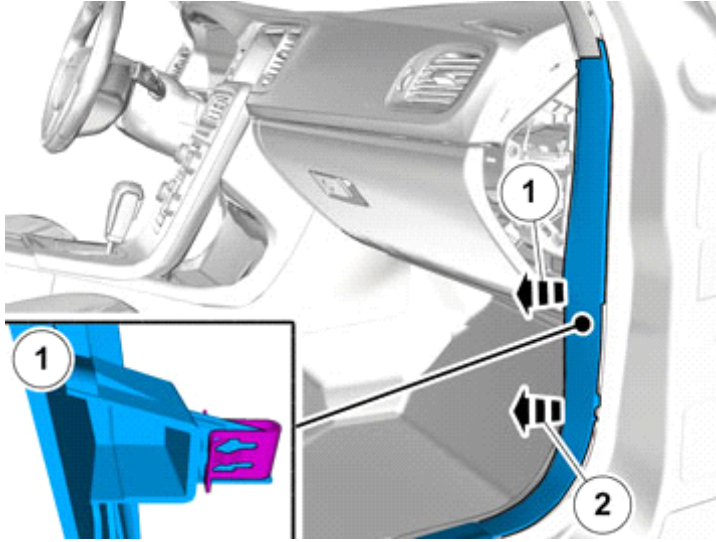

IMG-344928

9

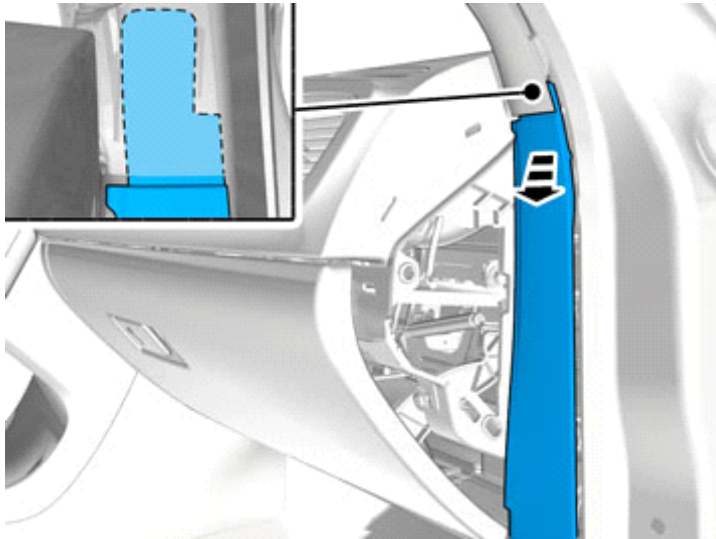

IMG-344929

10

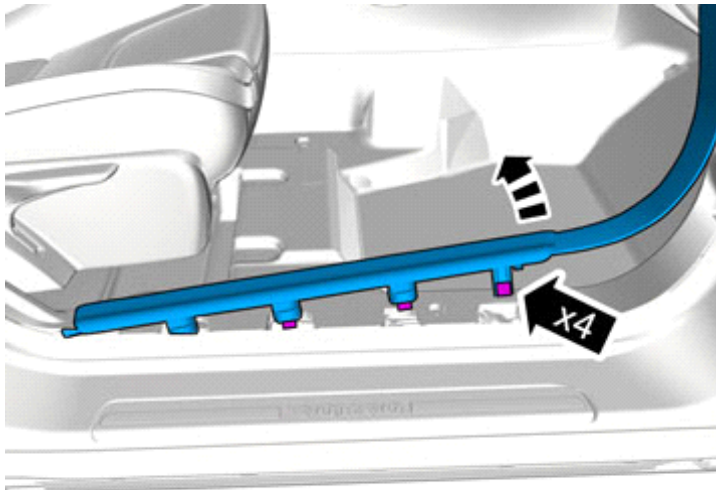

IMG-344930



Installation instructions, accessories

Volvo Car Corporation Gothenburg, Sweden

11

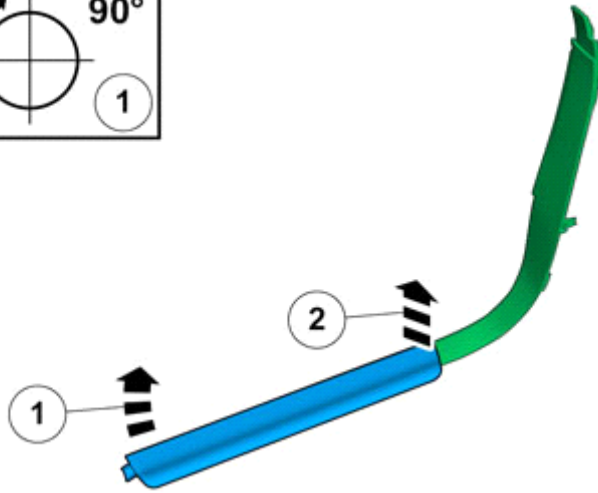
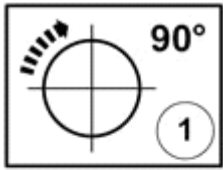

IMG-344451

12

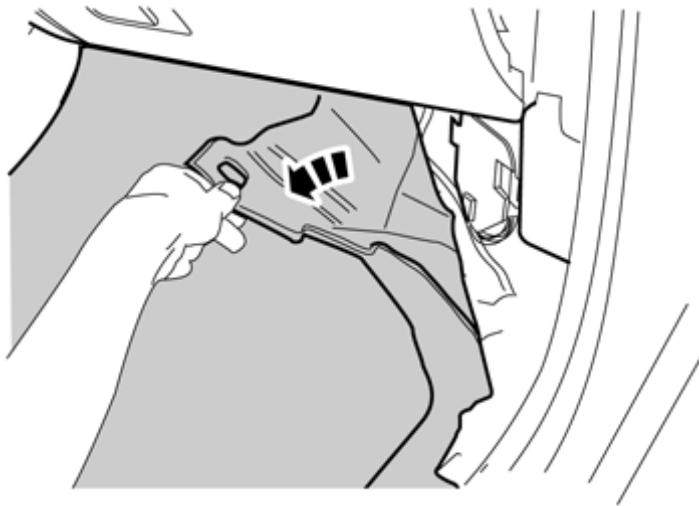

Fold the carpet to the side.

IMG-269484



Installation instructions, accessories

Volvo Car Corporation Gothenburg, Sweden

13

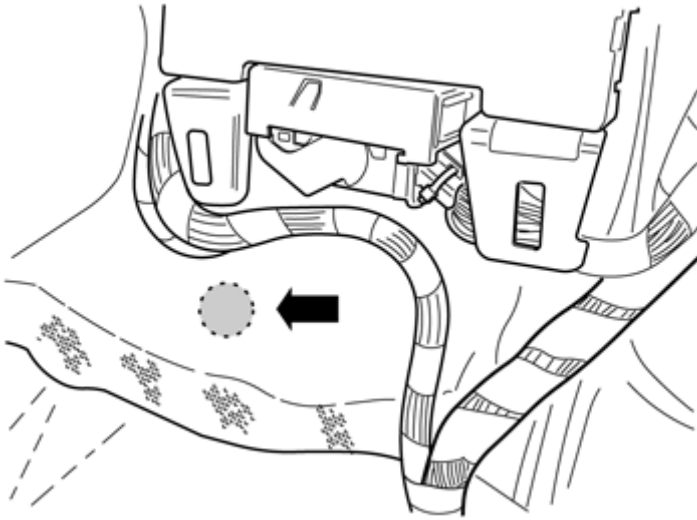

IMG-307603

Locate the rubber grommet under the insulation and press it out.

14

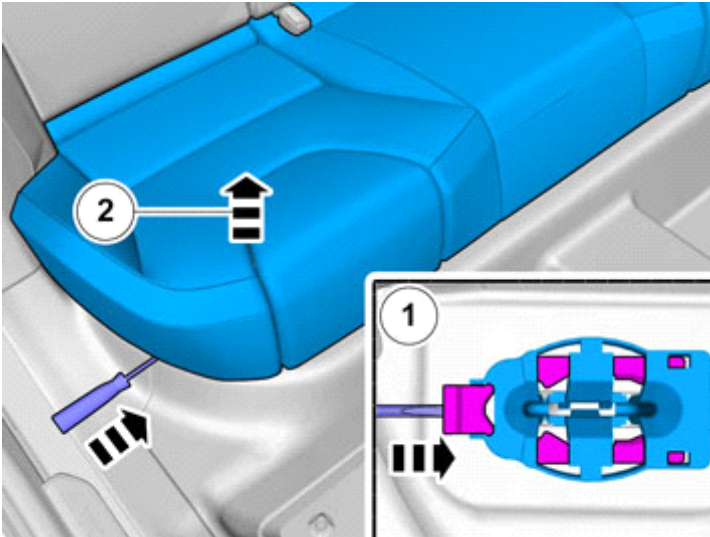

IMG-342372

Repeat on the other side.

15

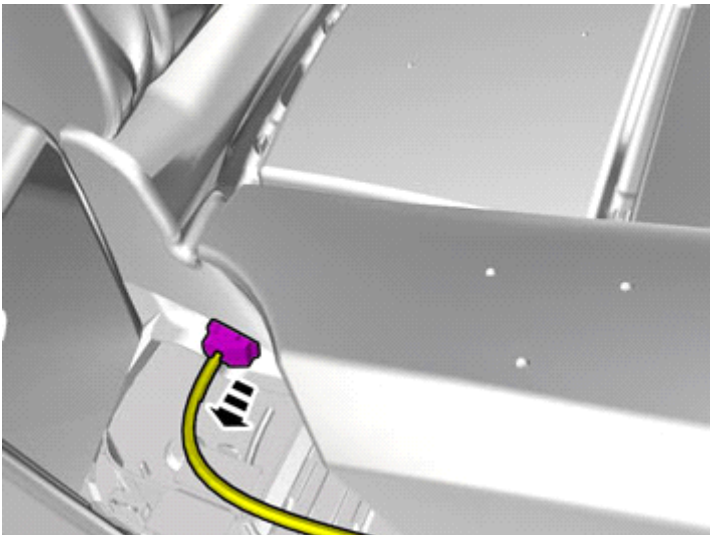

IMG-341902

Disconnect the connector, if applicable.

Repeat on the other side.



Installation instructions, accessories

Volvo Car Corporation Gothenburg, Sweden

16

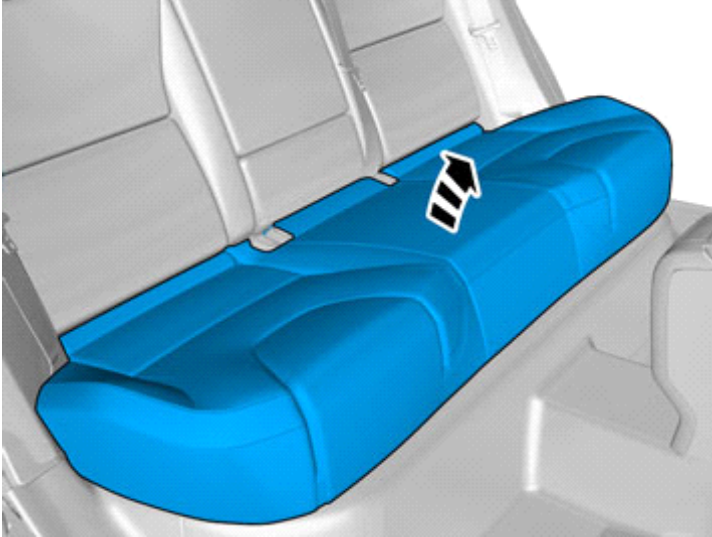

IMG-360124

17

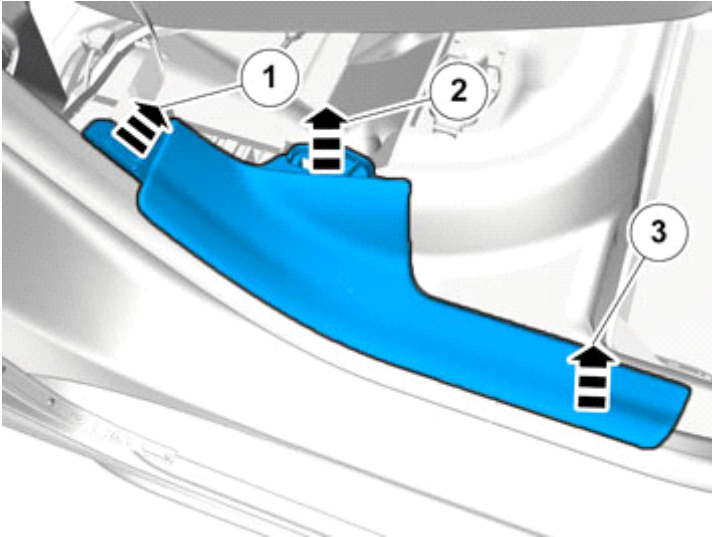

IMG-341906

Remove the panel.

18

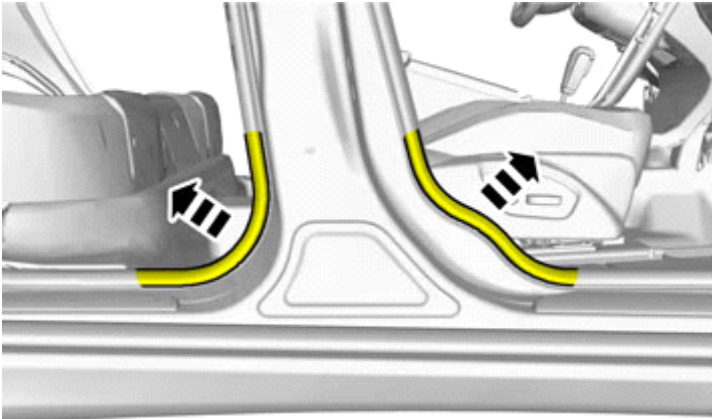

Remove the weatherstrips.

IMG-307605



Installation instructions, accessories

Volvo Car Corporation Gothenburg, Sweden

19

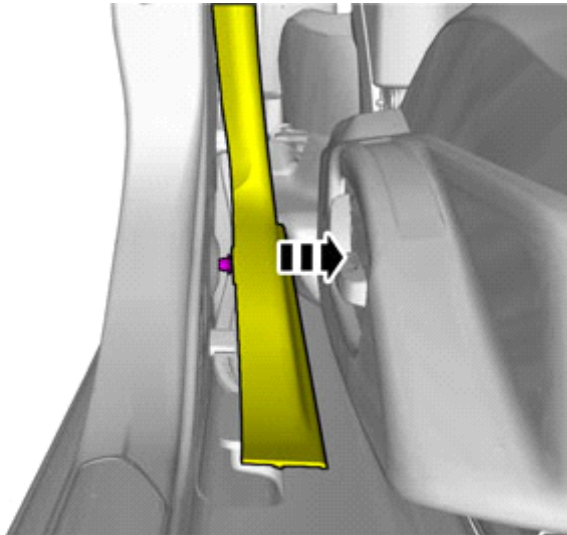

Detach the panel.

IMG-307606

20

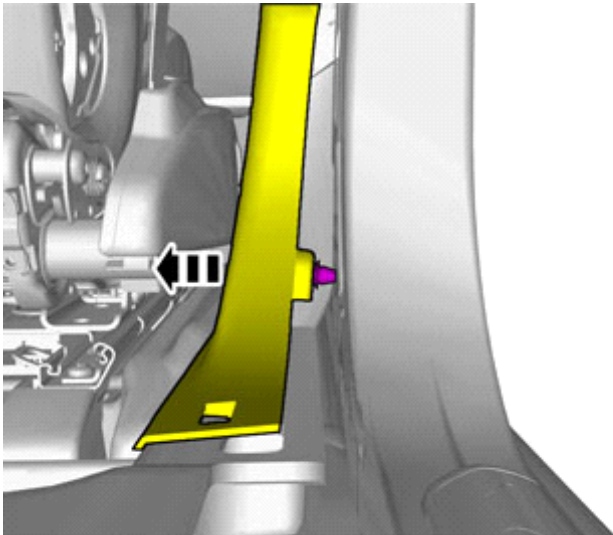

Detach the panel.

IMG-307607



Installation instructions, accessories

Volvo Car Corporation Gothenburg, Sweden

21

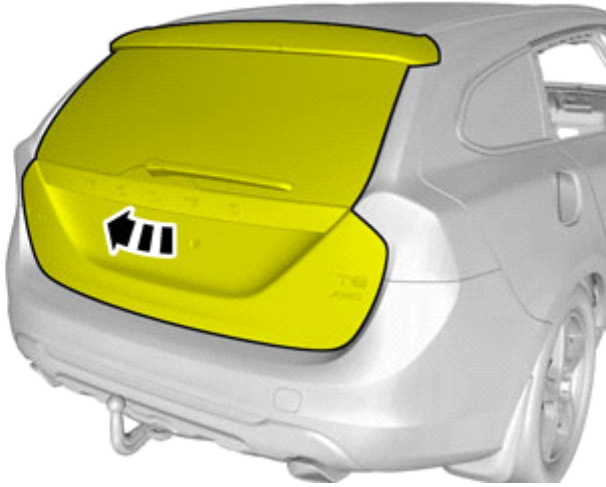

IMG-346181

22

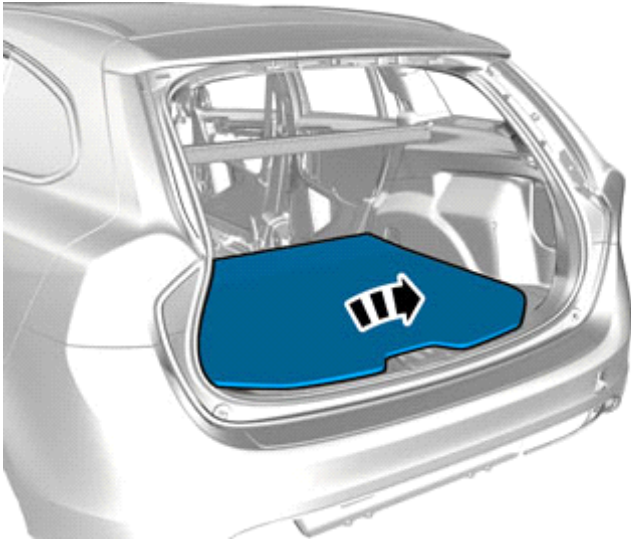

IMG-343412

23

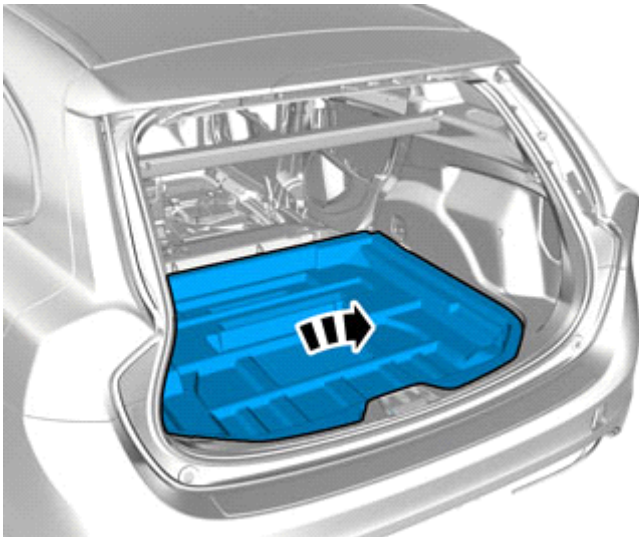

IMG-343413



Installation instructions, accessories

Volvo Car Corporation Gothenburg, Sweden

24

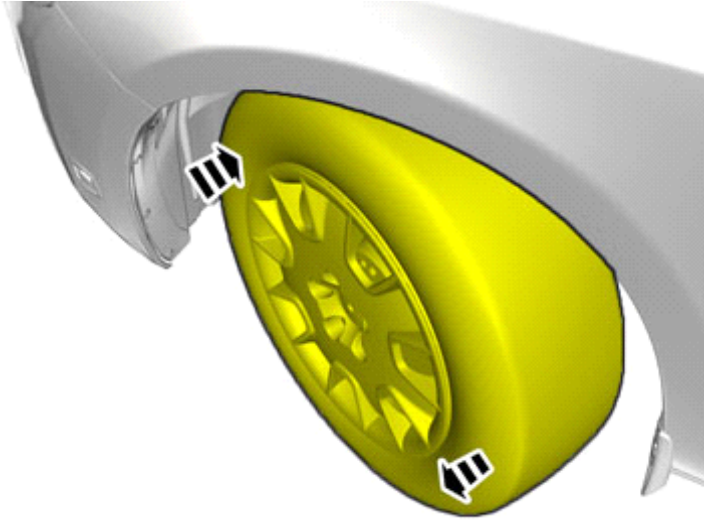

Turn the wheel inwards.

IMG-341912

25

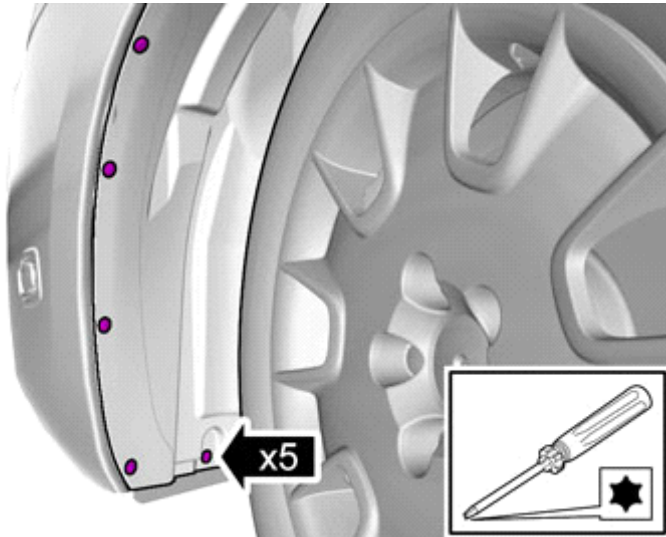

Remove the screws.

IMG-341913

Vehicles with headlamp washers



Installation instructions, accessories

Volvo Car Corporation Gothenburg, Sweden

26

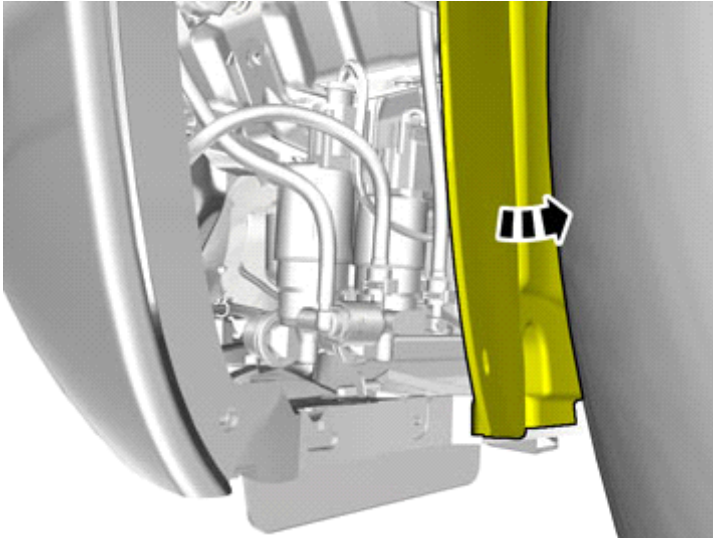

IMG-341914

Fold the wing liner to one side.

27

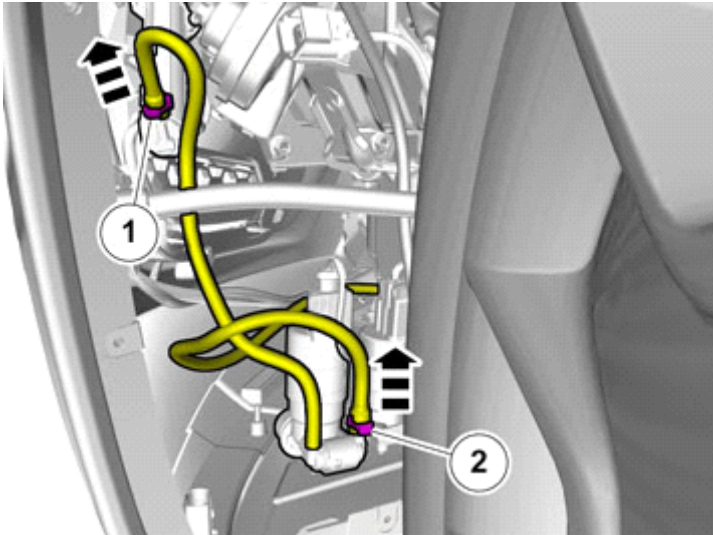

IMG-341915

Warning!

Be prepared to collect escaping fluid.

1.

Note!

Tape the hose high up on the washer fluid reservoir to prevent washer fluid from coming out.

2. Take a piece of washer hose. Tie a knot in it and place it on the washer pump to prevent the washer fluid reservoir from emptying.

All vehicles



Installation instructions, accessories

Volvo Car Corporation Gothenburg, Sweden

28

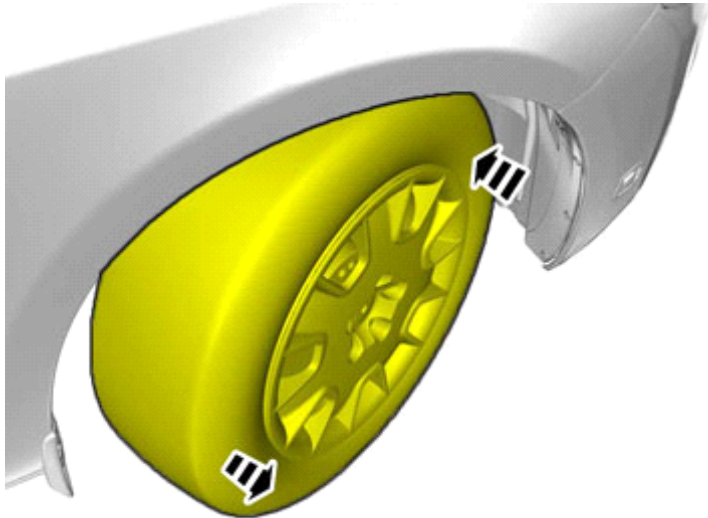

Turn the wheel inwards.

IMG-341916

29

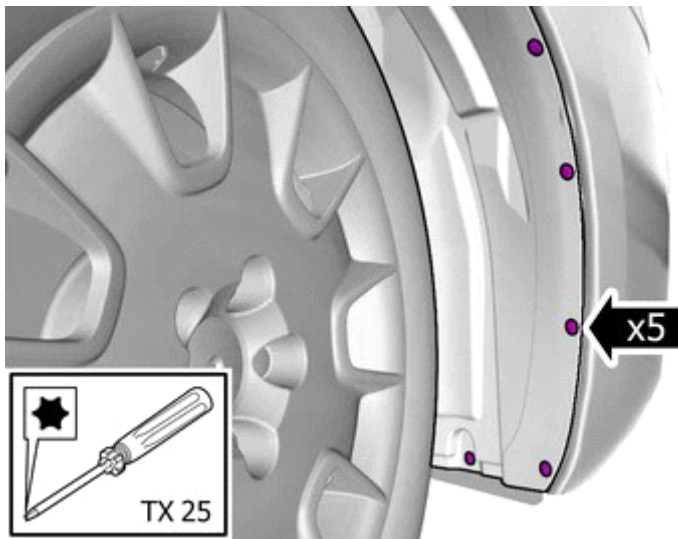

Remove the screws.

IMG-341917

30

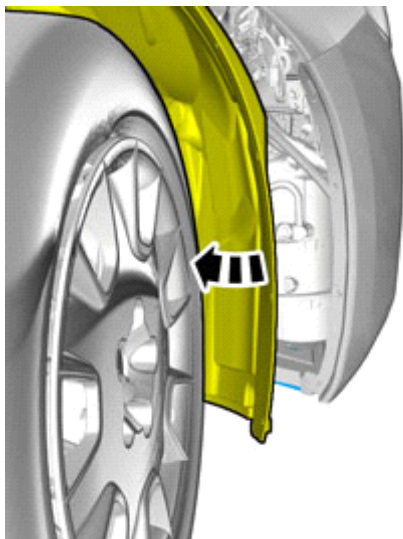

Fold the wing liner to one side.

IMG-341918



Installation instructions, accessories

Volvo Car Corporation Gothenburg, Sweden

31

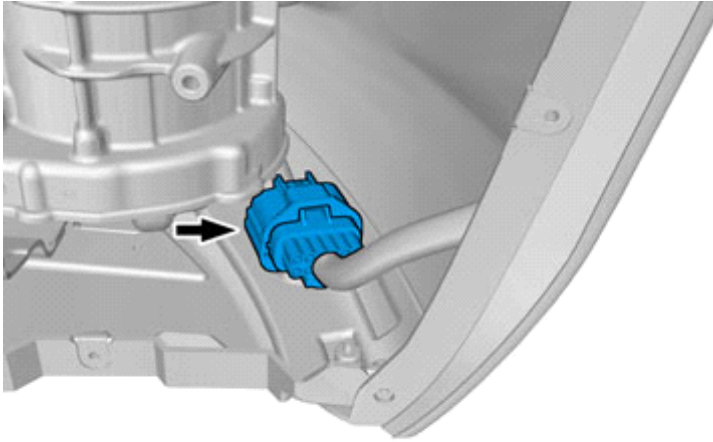

Locate the connector.

IMG-378274

32

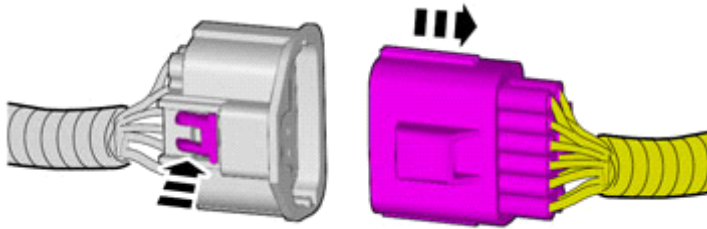

1. Depress the locking device.
2. Disconnect the connector.

IMG-378285

33

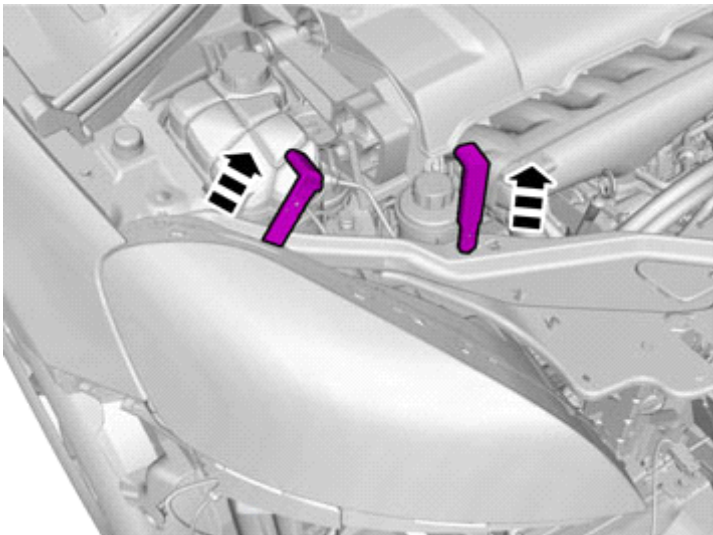

RHD: The procedure is carried out on the opposite side.

IMG-307687



Installation instructions, accessories

Volvo Car Corporation Gothenburg, Sweden

34

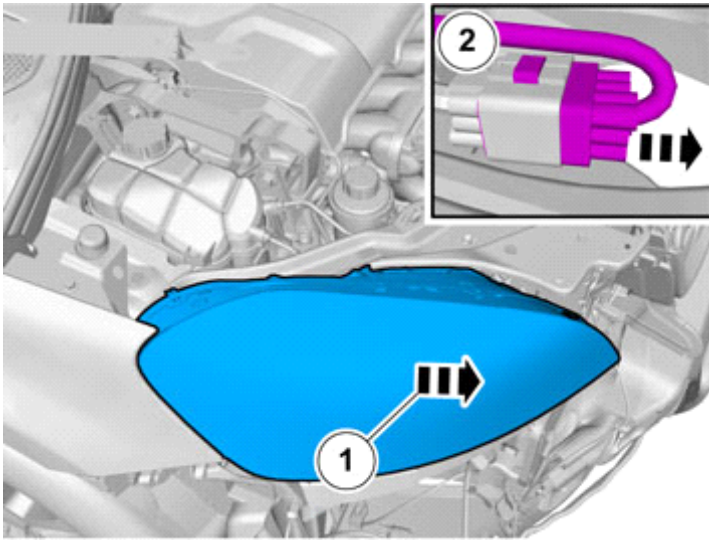

IMG-307688

RHD: The procedure is carried out on the opposite side.

35

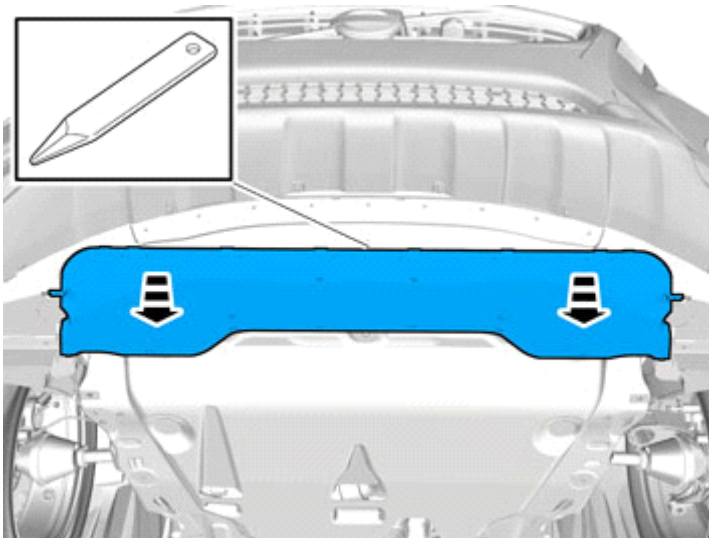

IMG-341924



Installation instructions, accessories

Volvo Car Corporation Gothenburg, Sweden

36

Remove the clips.

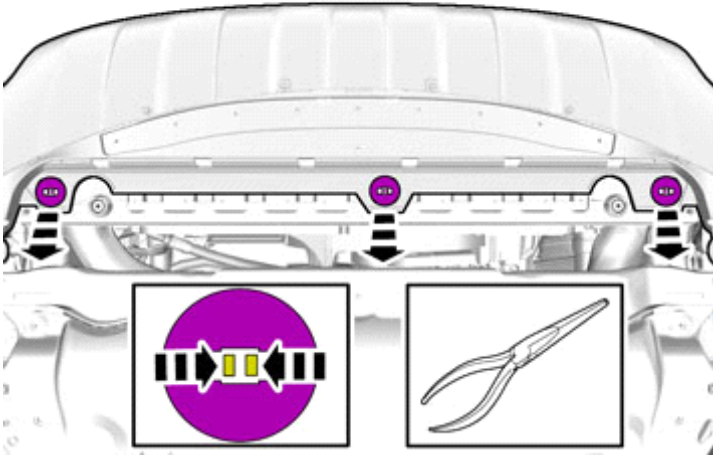

IMG-341927

37

Remove the clips.

Remove the screws.

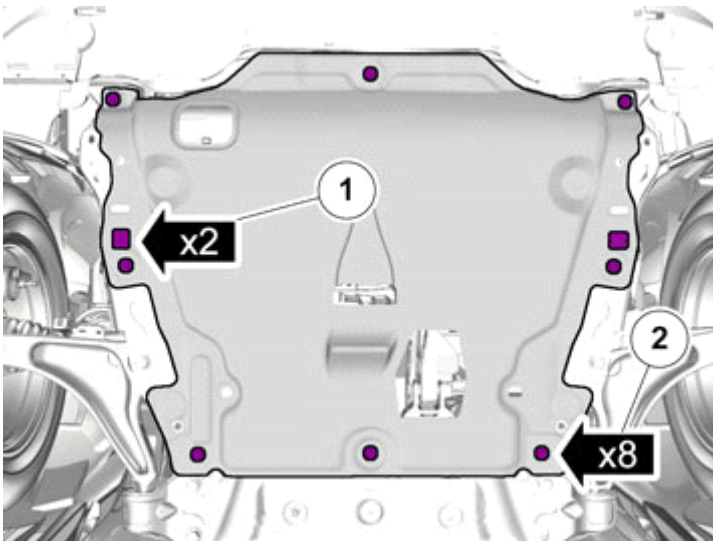

IMG-341931

38

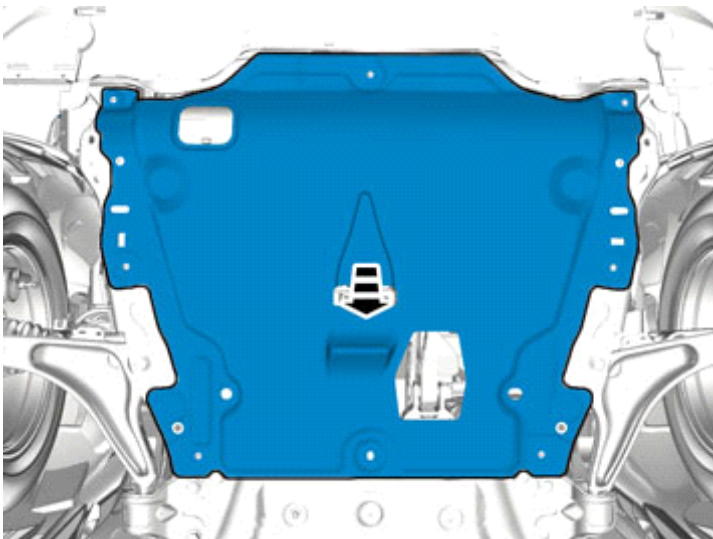

IMG-341932



Installation instructions, accessories

Volvo Car Corporation Gothenburg, Sweden

39

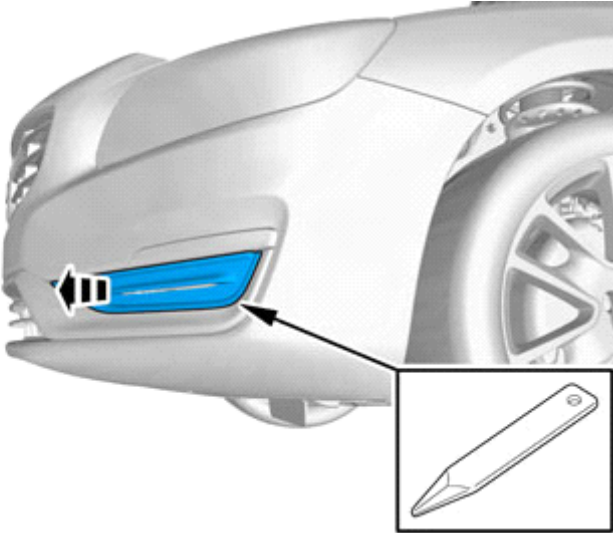

IMG-378560

Repeat on the other side.

The part is not to be reused.

40

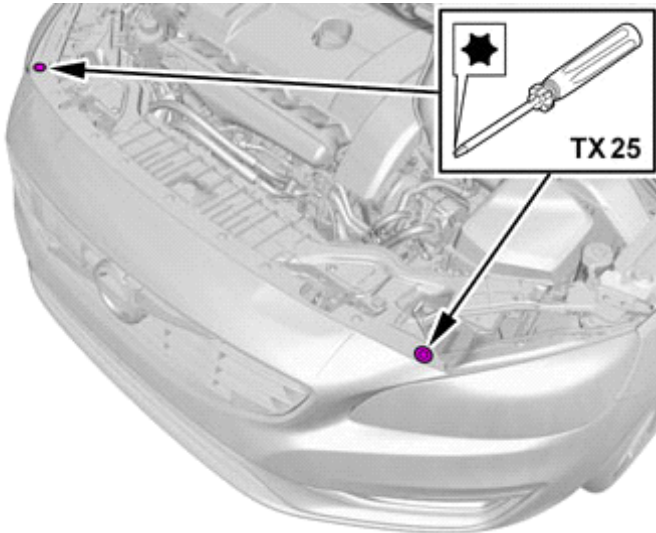

IMG-378108

Remove the screws.

41

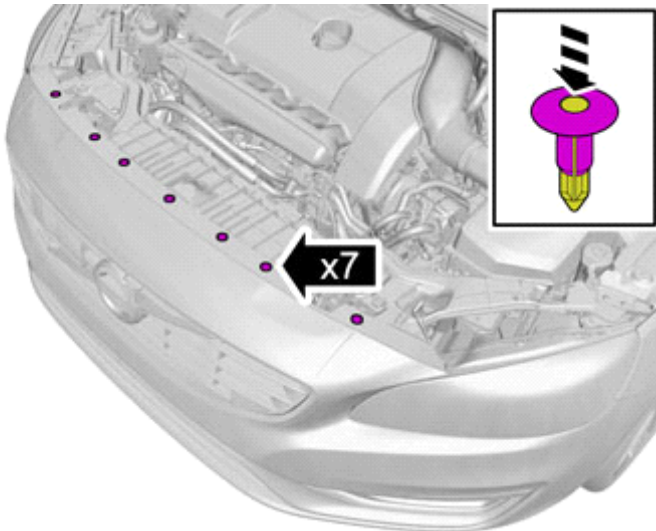

IMG-378111

Remove the clips.



Installation instructions, accessories

Volvo Car Corporation Gothenburg, Sweden

42

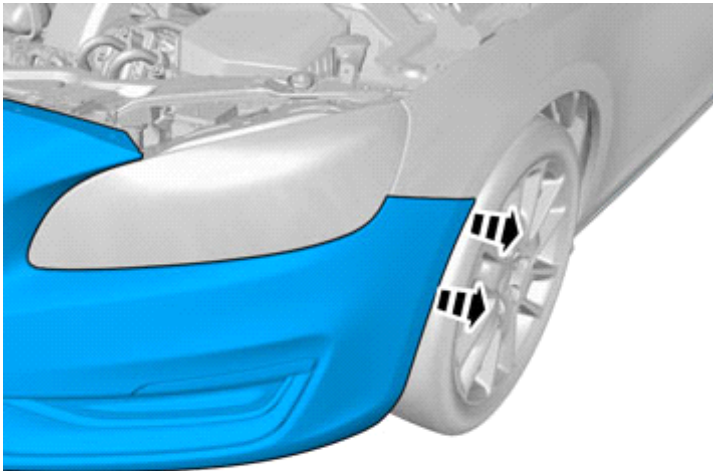

Repeat on the other side.

IMG-378561

43



Caution!
Place the Bumper Cover on a suitable surface.

IMG-378577



Installation instructions, accessories

Volvo Car Corporation Gothenburg, Sweden

44

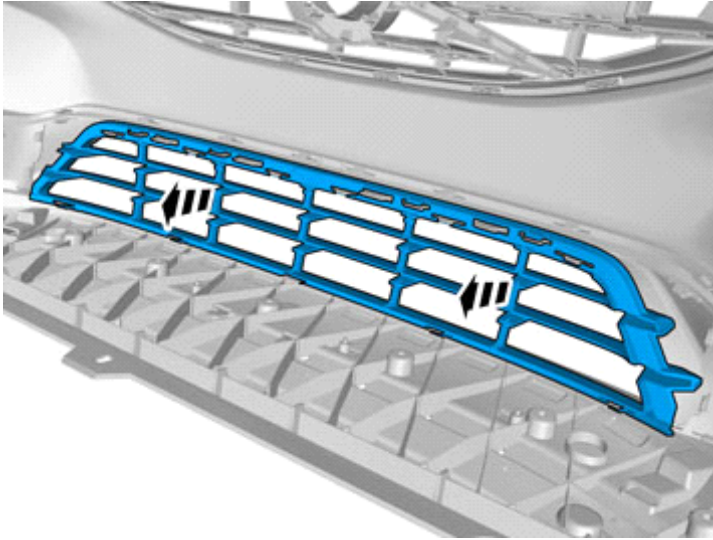

IMG-378579

The part is not to be reused.

Accessory installation

45

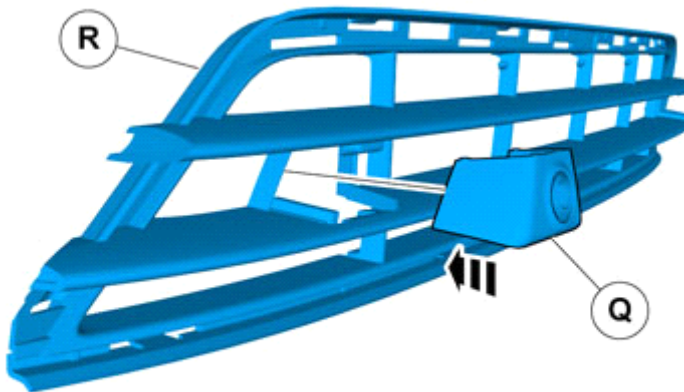

IMG-378581

Repeat on the other side.



Installation instructions, accessories

Volvo Car Corporation Gothenburg, Sweden

46

Repeat on the other side.

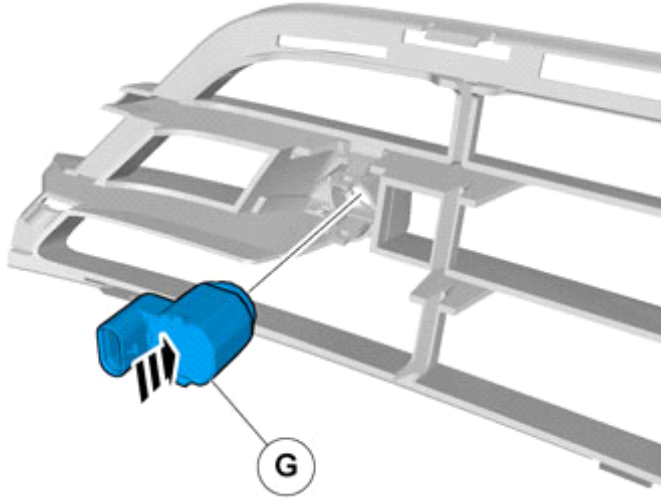

IMG-378583

47

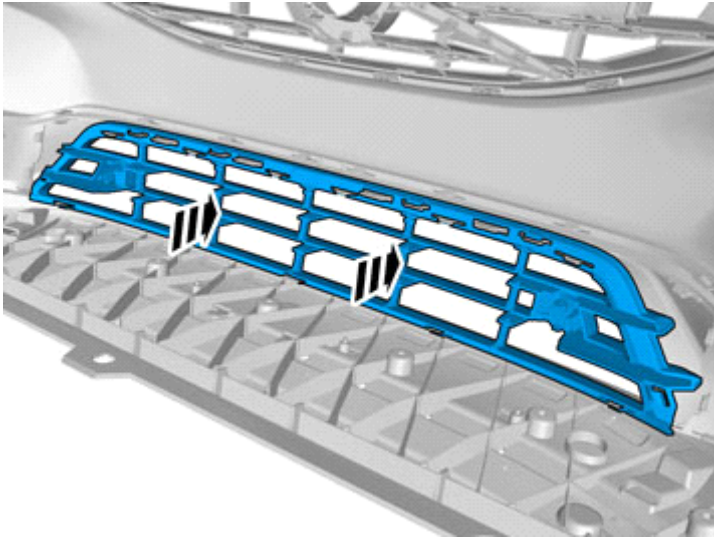

IMG-378584

48

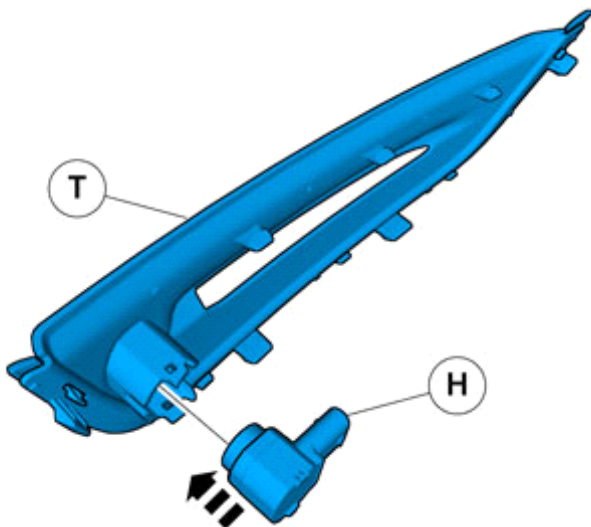

IMG-378590



Installation instructions, accessories

Volvo Car Corporation Gothenburg, Sweden

49

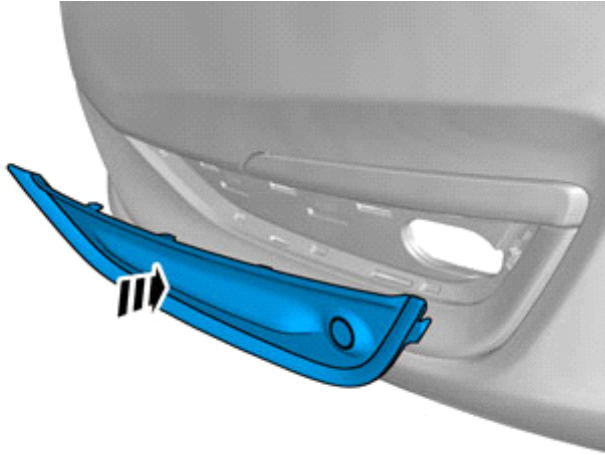

Repeat on the other side.

IMG-378591

50

RHD: The cable harness is positioned mirrored.

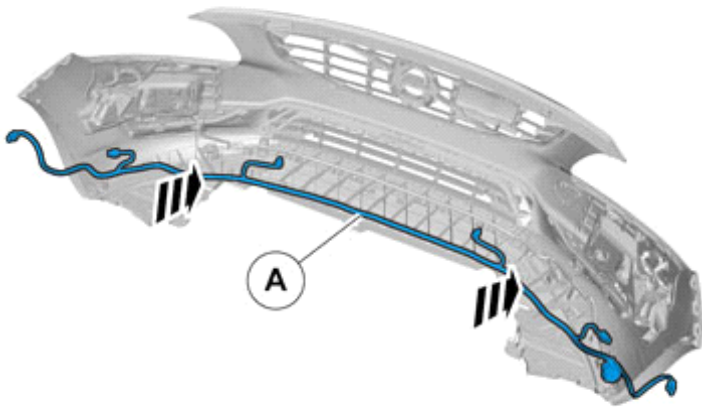

IMG-378592

51

Connect the connectors.

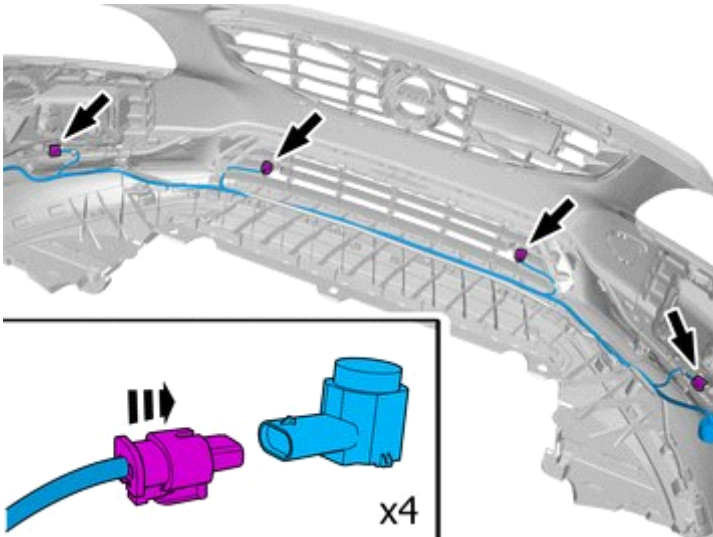

IMG-378593



Installation instructions, accessories

Volvo Car Corporation Gothenburg, Sweden

52

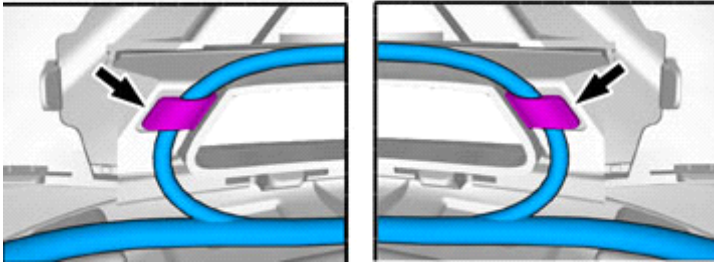
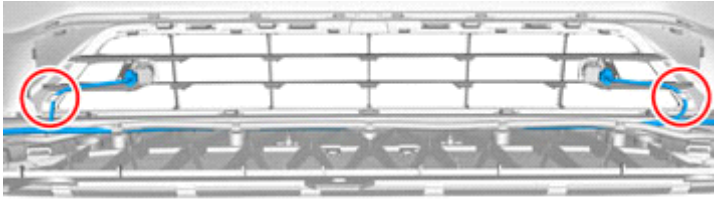

IMG-378598

53

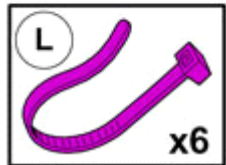
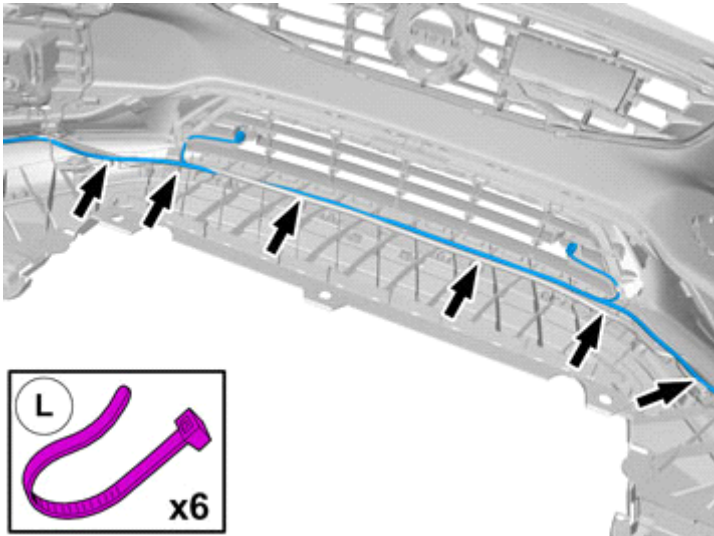

IMG-378596



Installation instructions, accessories

Volvo Car Corporation Gothenburg, Sweden

54

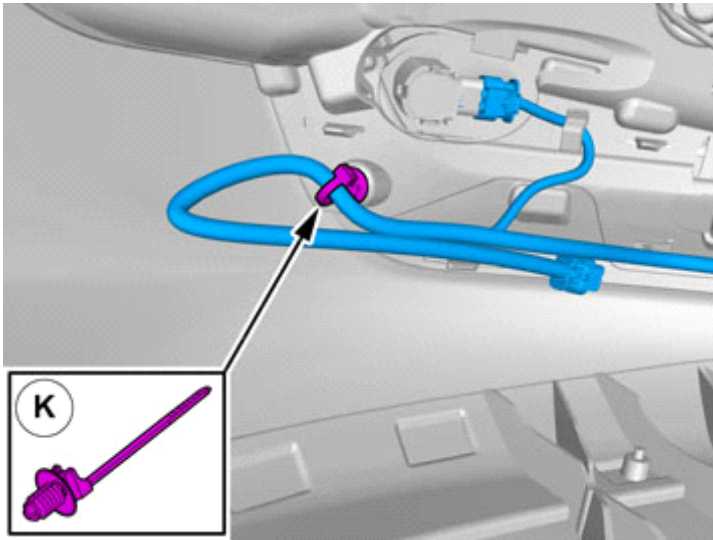

IMG-378599

55

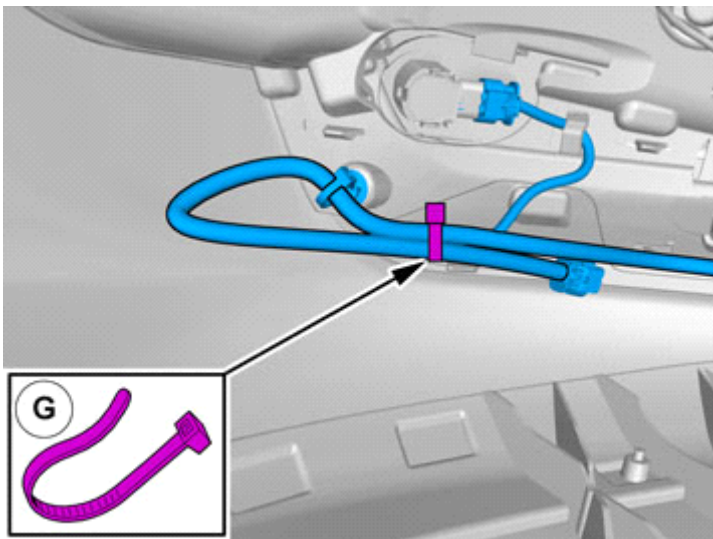

IMG-378601

Attach the connector to the wiring harness.

The connector is not to be used.

Repeat on the other side.

56

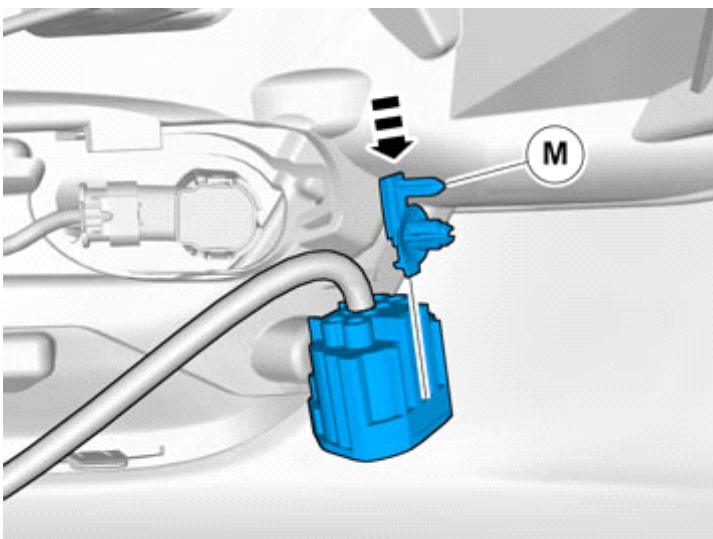

IMG-378602



Installation instructions, accessories

Volvo Car Corporation Gothenburg, Sweden

57

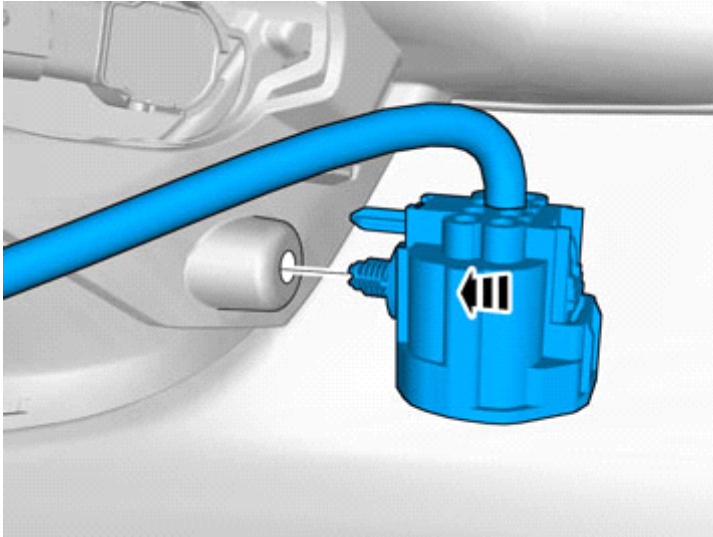

IMG-378603

Left hand drive vehicles

58

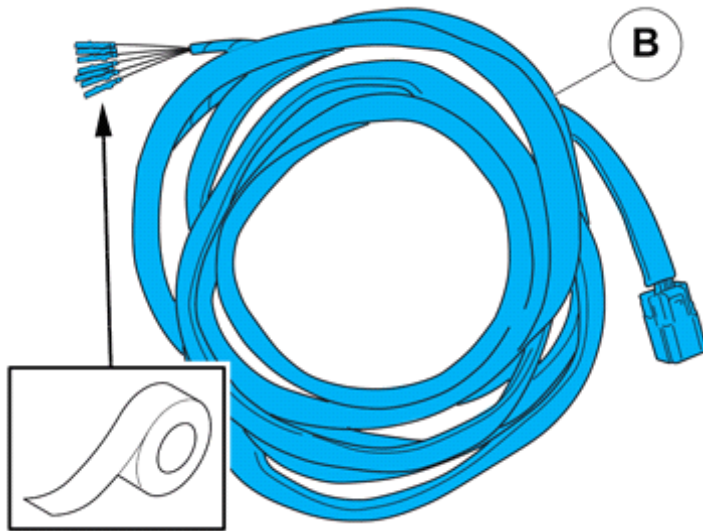

IMG-373258

Use: , Electrical tape



Installation instructions, accessories

Volvo Car Corporation Gothenburg, Sweden

59

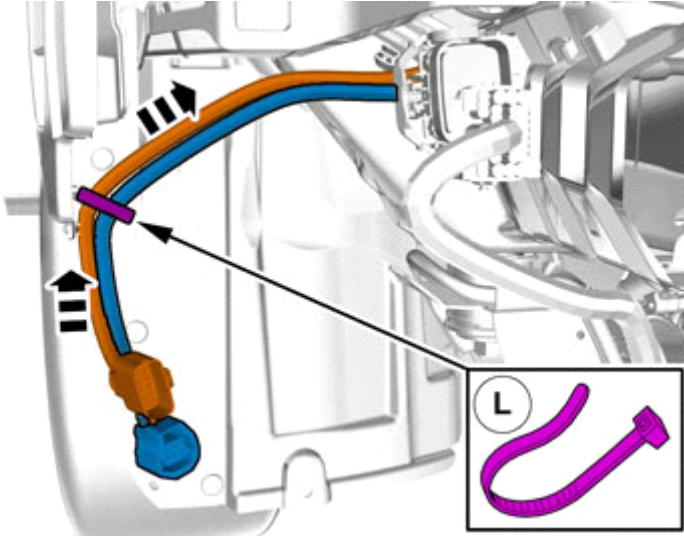

IMG-378253

60

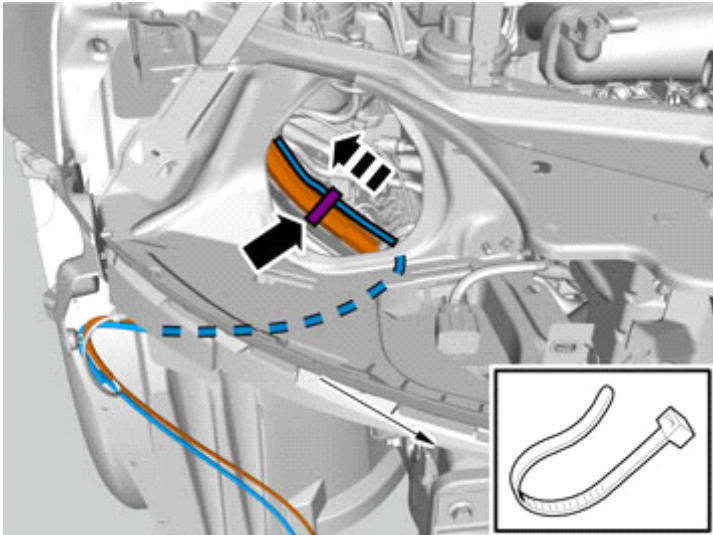

IMG-307882

Right-hand drive vehicles



Installation instructions, accessories

Volvo Car Corporation Gothenburg, Sweden

61

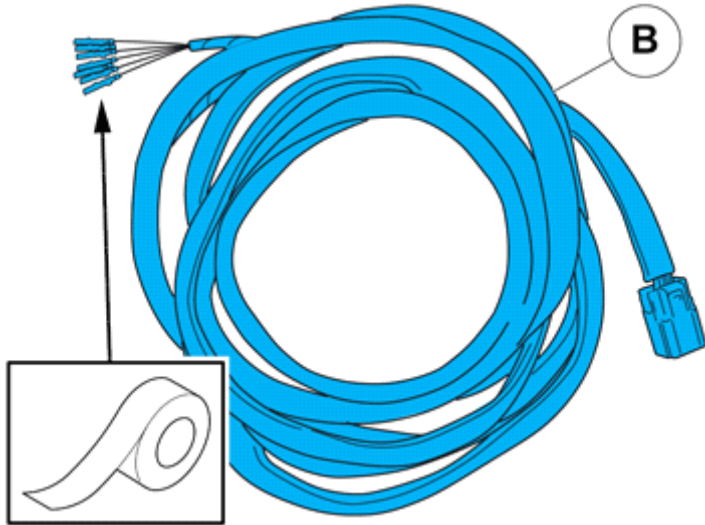

Use: , Electrical tape

IMG-373258

62

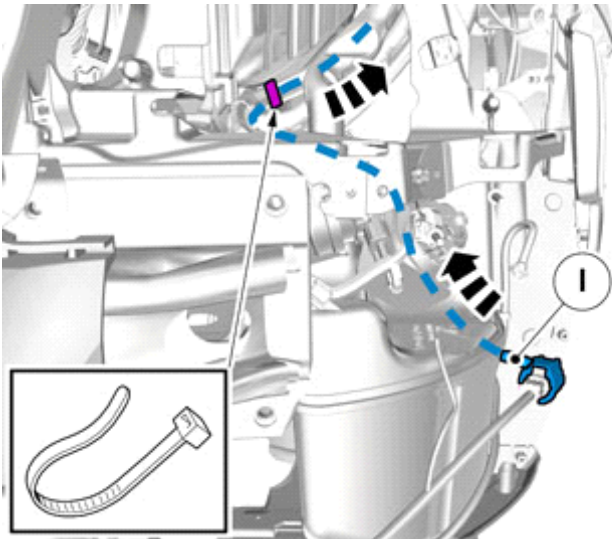

IMG-341962

63

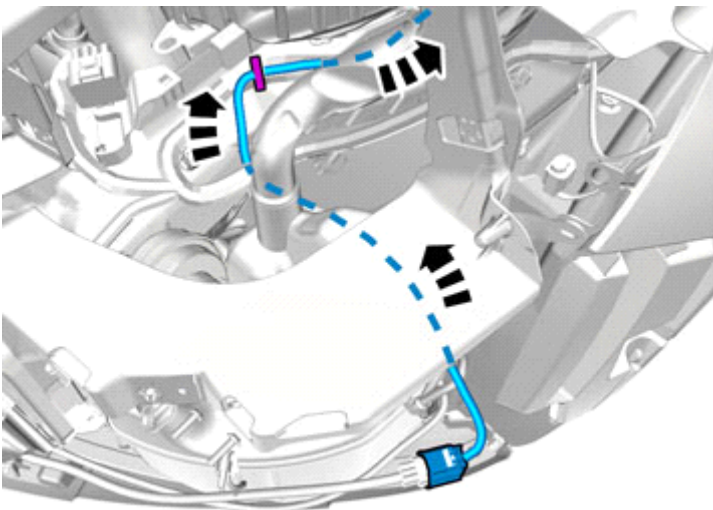

IMG-341963



Installation instructions, accessories

Volvo Car Corporation Gothenburg, Sweden

All vehicles

64

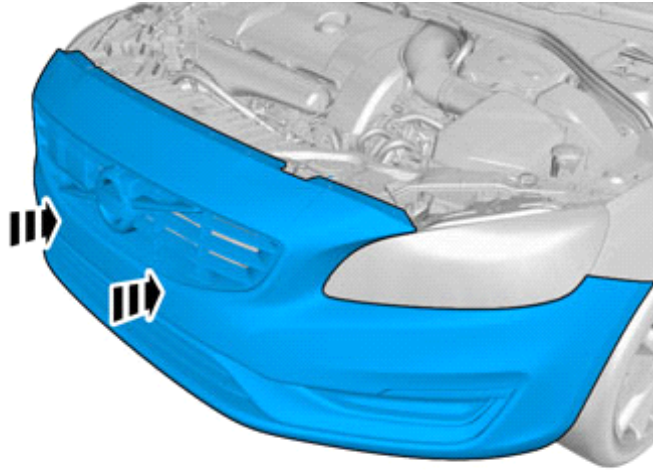

Place the Bumper Cover in position for installation.

IMG-378609

Left hand drive vehicles

65

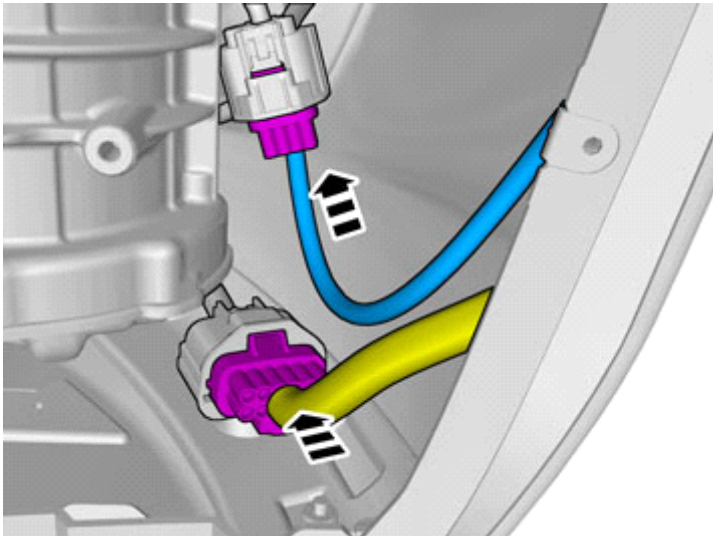

Connect the connectors.

IMG-378276

Right-hand drive vehicles



Installation instructions, accessories

Volvo Car Corporation Gothenburg, Sweden

66

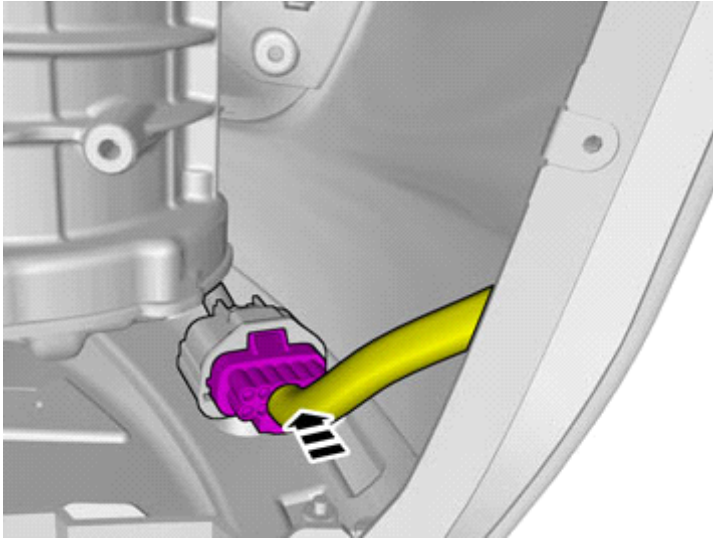

IMG-378280

Connect the connector.

67

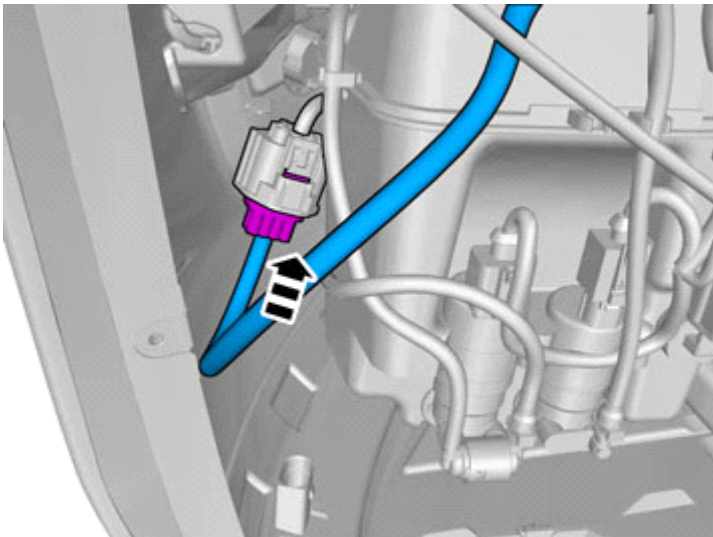

IMG-378611

Connect the connector.

Vehicles with headlamp washers



Installation instructions, accessories

Volvo Car Corporation Gothenburg, Sweden

68

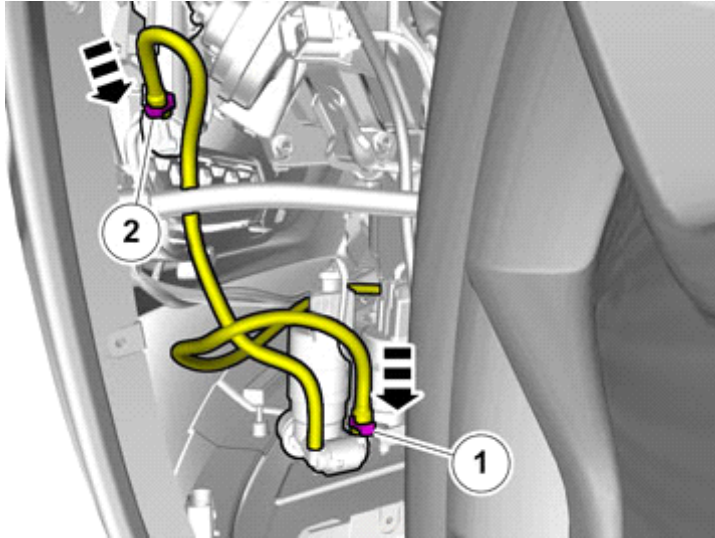

IMG-350323

Reinstall the removed parts in reverse order.

All vehicles

69

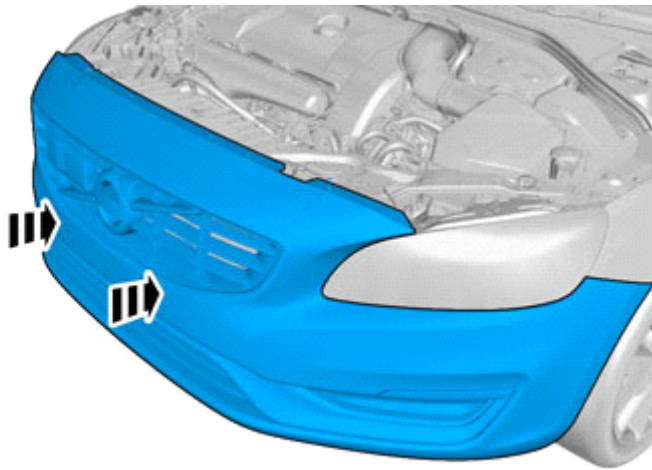

IMG-378609

Reinstall the bumper.

Left hand drive vehicles



Installation instructions, accessories

Volvo Car Corporation Gothenburg, Sweden

70

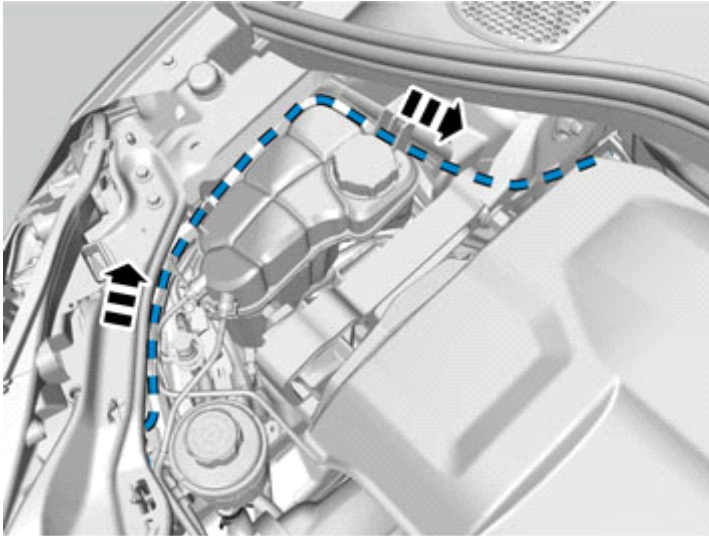

IMG-307909

Caution!

Make sure to locate the wiring in such a way that any damage caused by heat or excessive wear is avoided.

Route the cable harness to the existing cable harness.

Reinstall the headlamp.

71

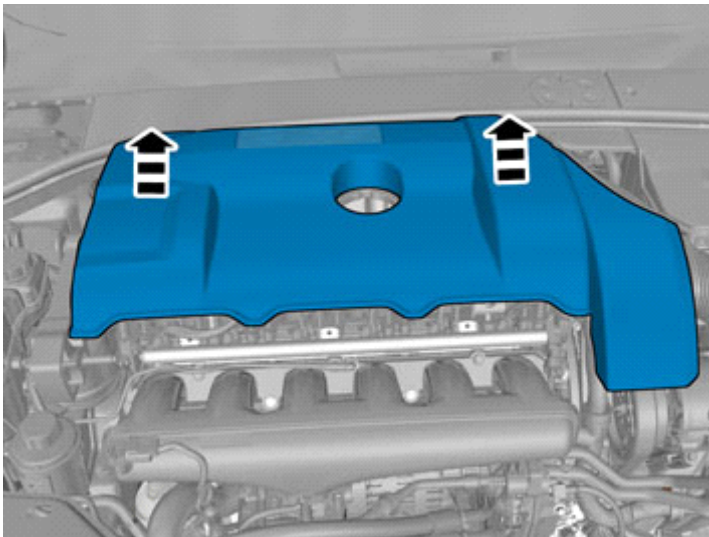

IMG-273585

72

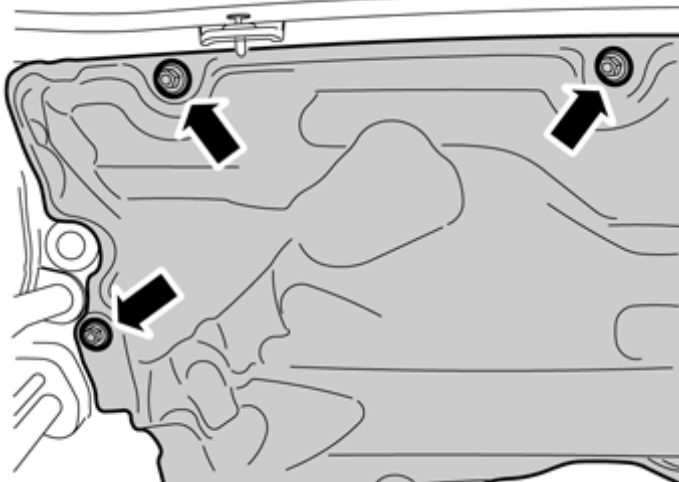

IMG-273586

Remove the nuts.



Installation instructions, accessories

Volvo Car Corporation Gothenburg, Sweden

73

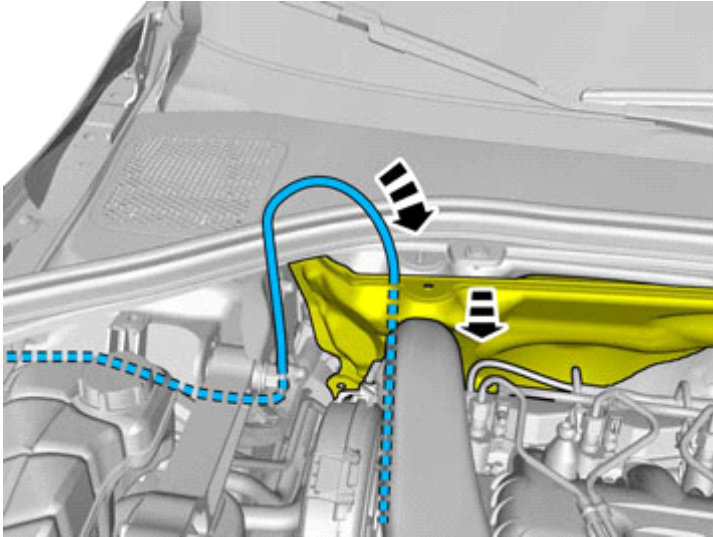

IMG-378517

74

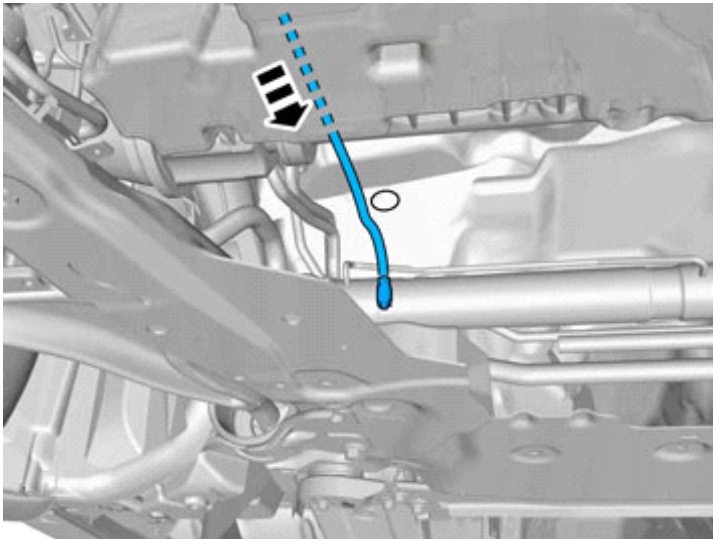

IMG-378516

Pull the wiring through.

75

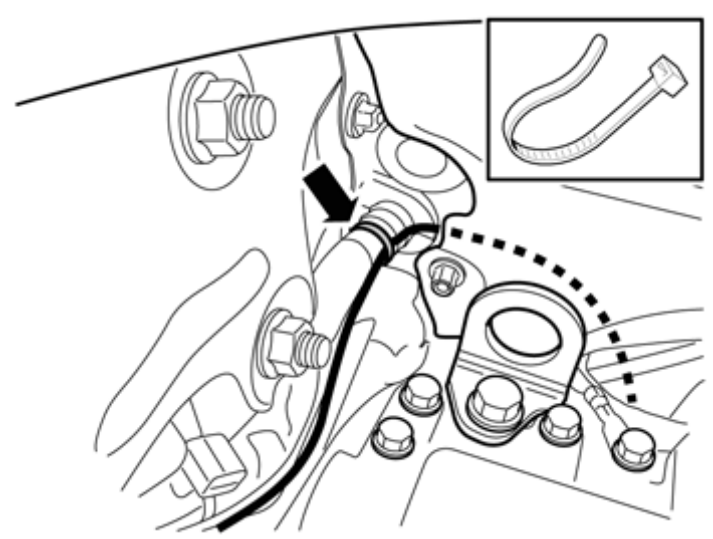

IMG-273588

Install the cable.



Installation instructions, accessories

Volvo Car Corporation Gothenburg, Sweden

Right-hand drive vehicles

76

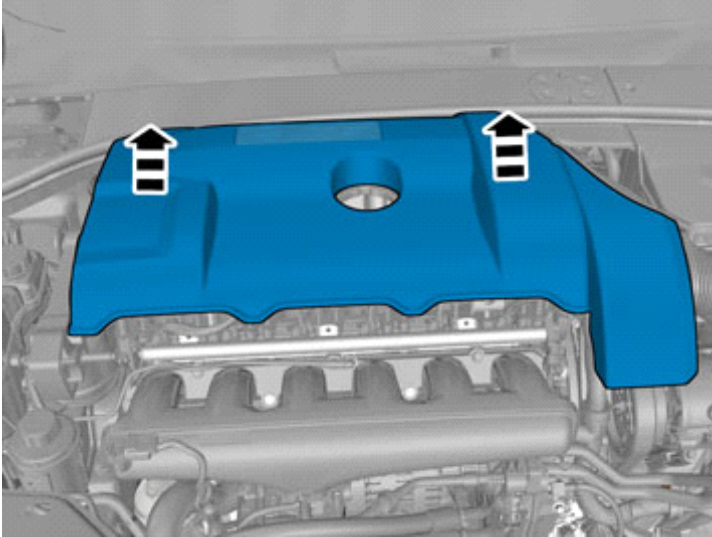

IMG-273585

77

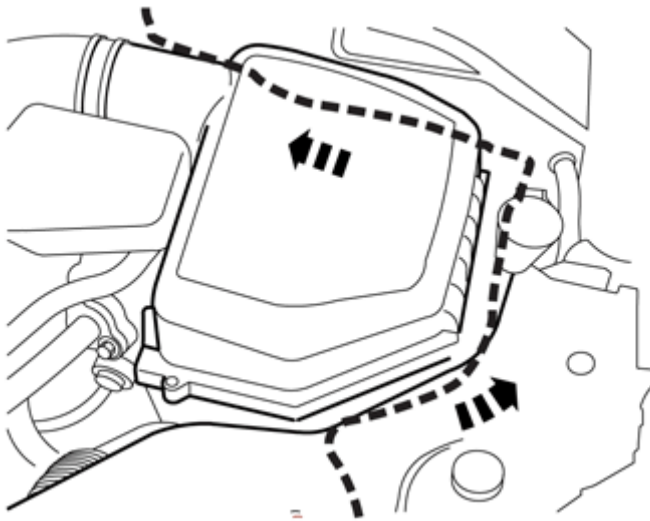

IMG-307910



Installation instructions, accessories

Volvo Car Corporation Gothenburg, Sweden

78

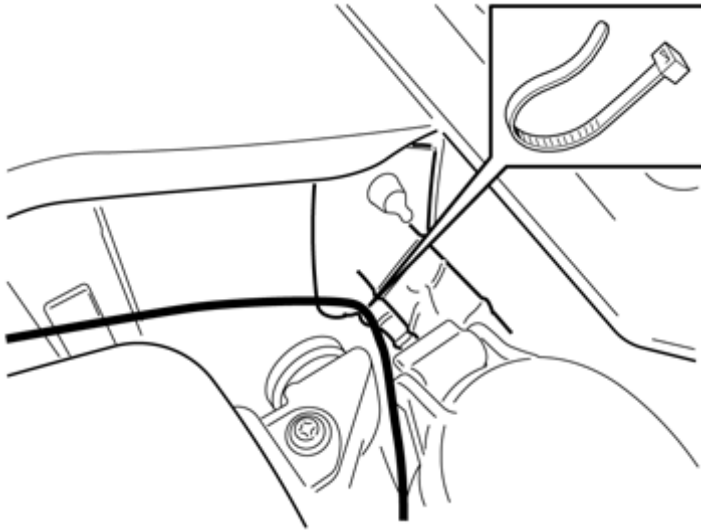

IMG-307911

Install the cable.

79

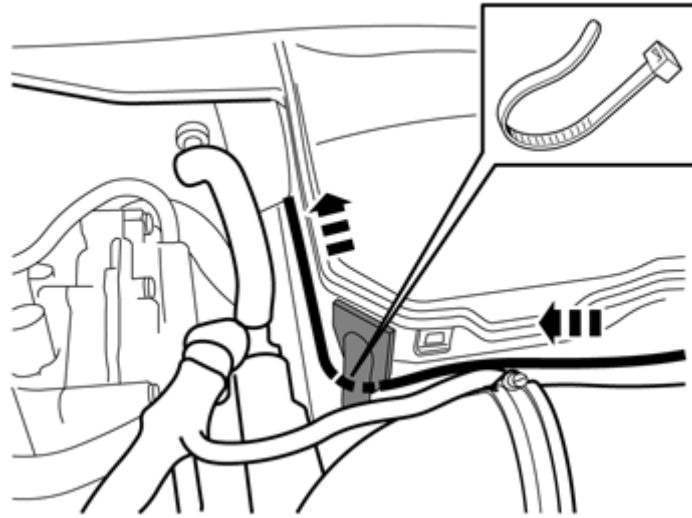

IMG-307912

Caution!

Make sure to locate the wiring in such a way that any damage caused by heat or excessive wear is avoided.

80

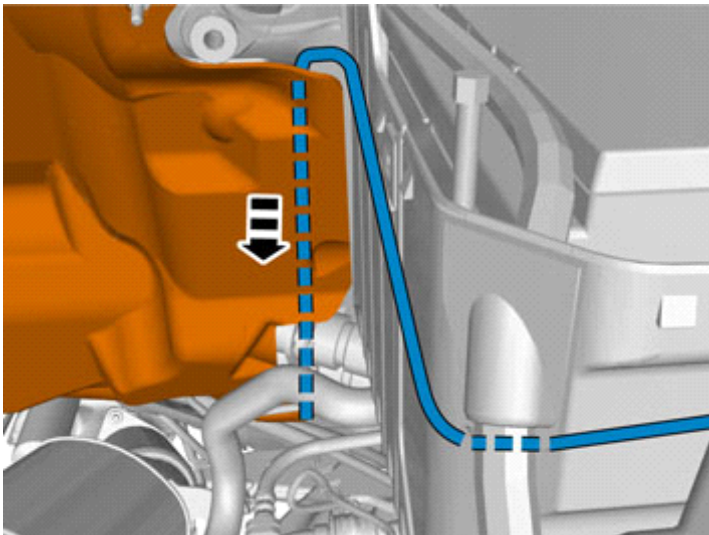

IMG-307913



Installation instructions, accessories

Volvo Car Corporation Gothenburg, Sweden

81

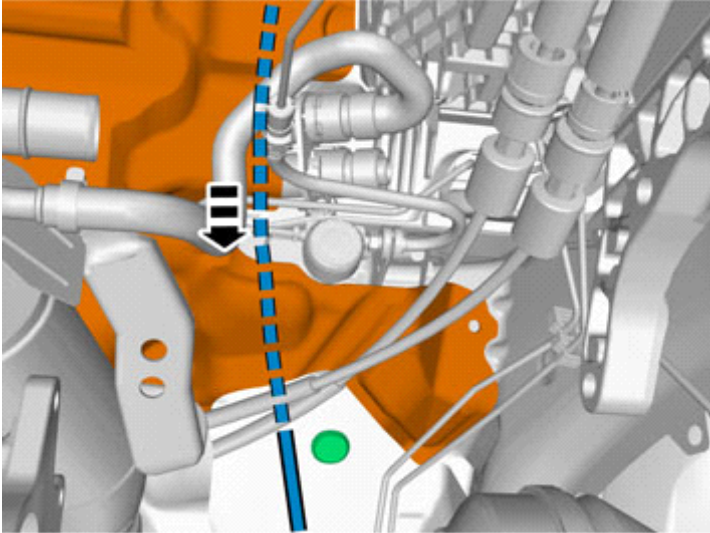

IMG-307914

All vehicles

82

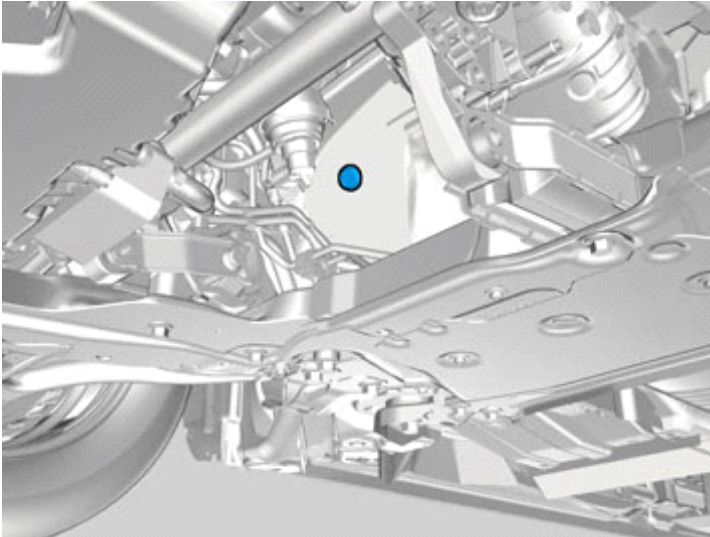

IMG-345879

Note!
Orientation view

Note!
On some markets the rubber grommet may be covered by the heat shield.



Installation instructions, accessories

Volvo Car Corporation Gothenburg, Sweden

83

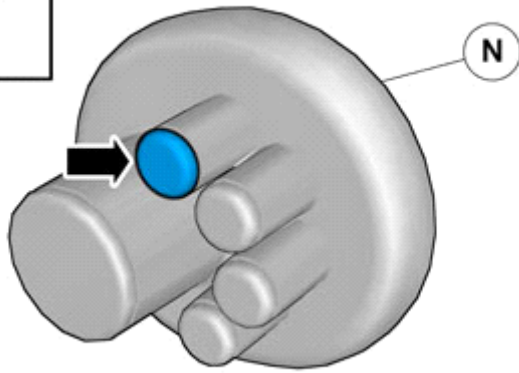
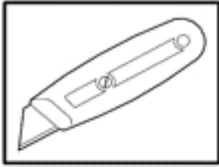

IMG-372722

84

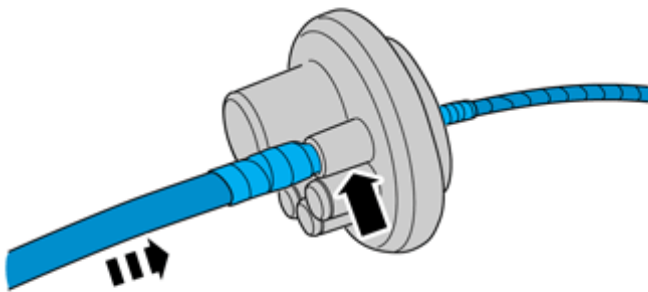

IMG-373255

85

Pull the wiring through.

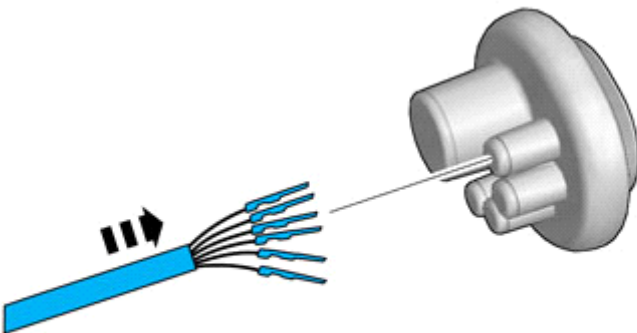

IMG-377675



Installation instructions, accessories

Volvo Car Corporation Gothenburg, Sweden

86

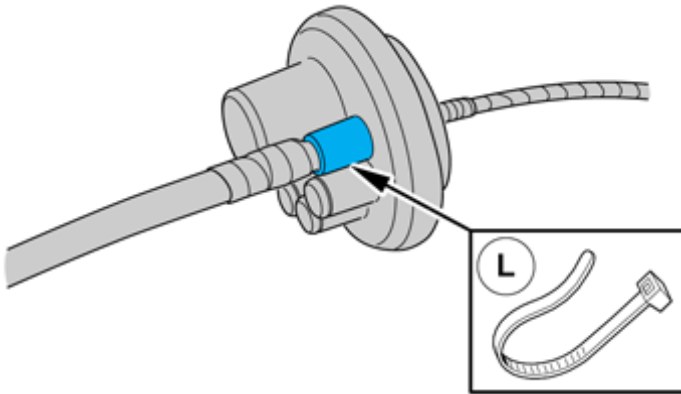

IMG-373254

87

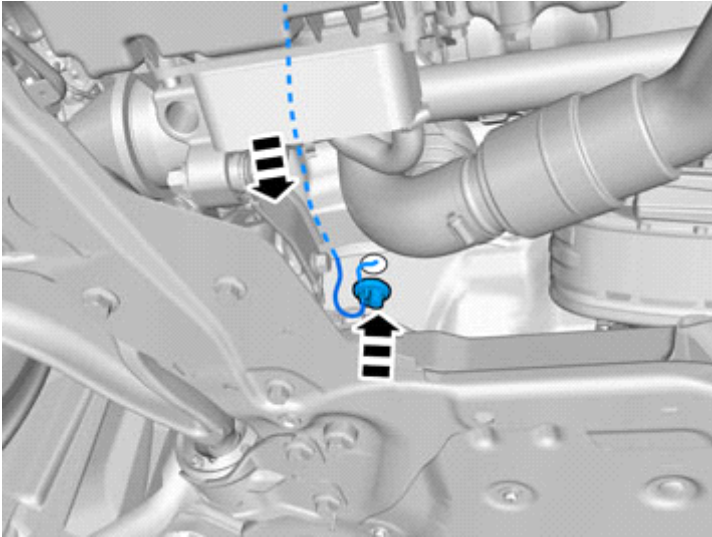

IMG-340544

Insert the cable in to the passenger compartment, adjust the cable length out into the engine compartment and secure the rubber grommet.

88

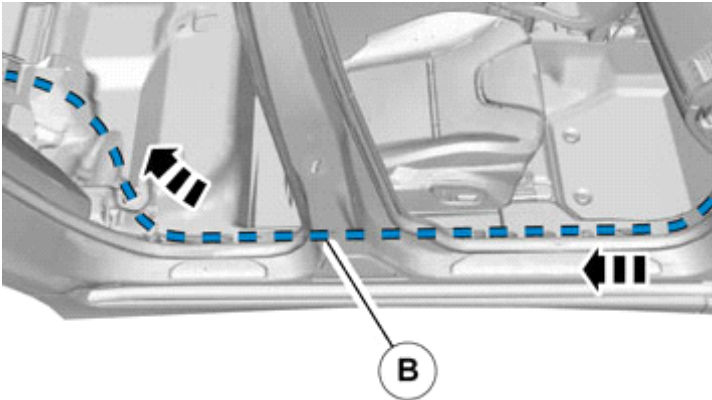

IMG-377674



Installation instructions, accessories

Volvo Car Corporation Gothenburg, Sweden

Right-hand drive vehicles

89

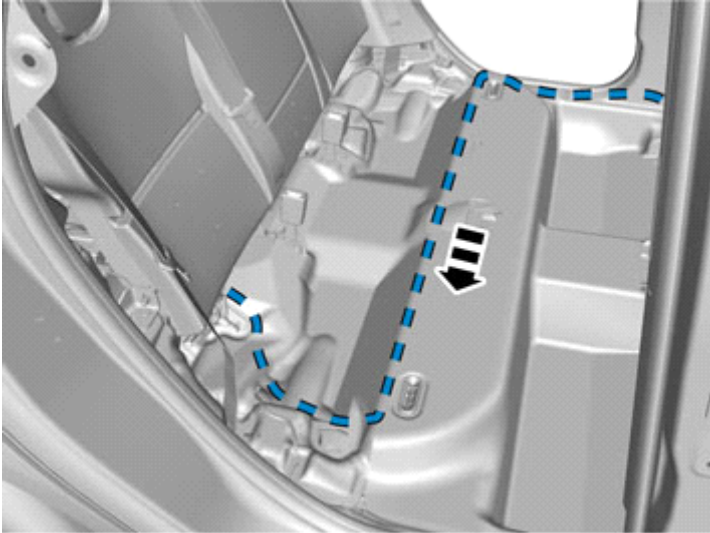

IMG-308083

All vehicles

90

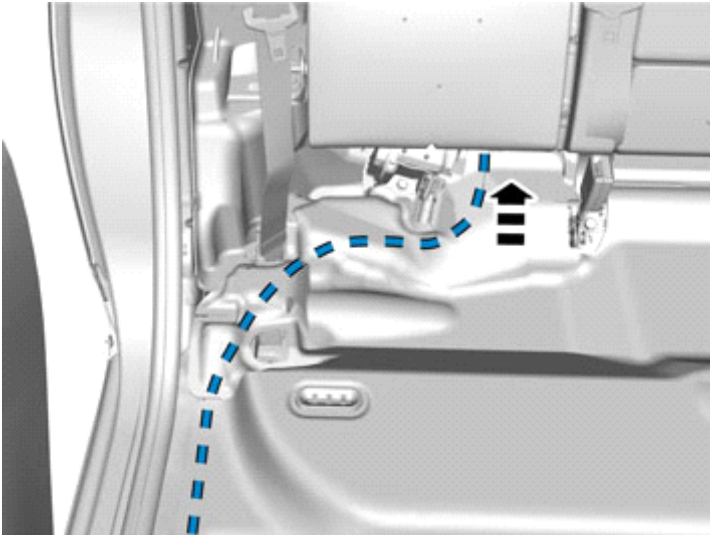

IMG-308084



Installation instructions, accessories

Volvo Car Corporation Gothenburg, Sweden

91

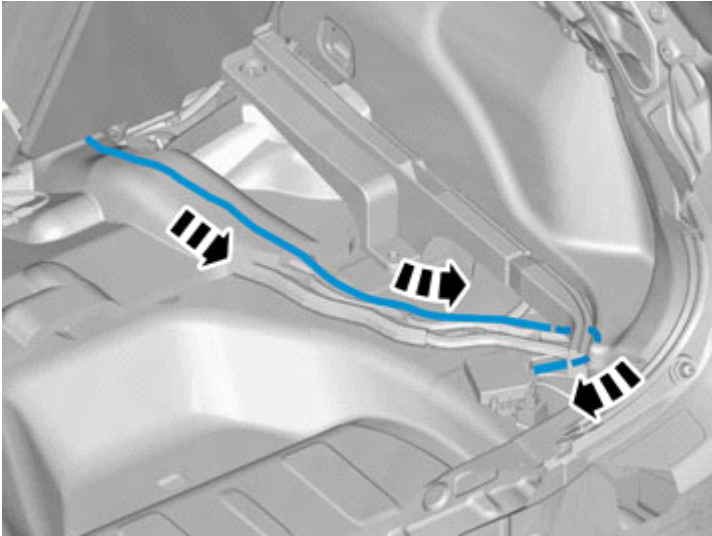

IMG-346331

Left hand drive vehicles

92

Connect the cable harness terminals in the connector as follows.

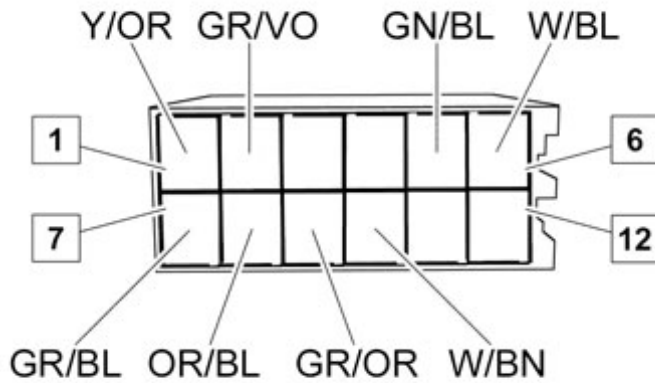

IMG-361341

Right-hand drive vehicles



Installation instructions, accessories

Volvo Car Corporation Gothenburg, Sweden

93

Connect the cable harness terminals in the connector as follows.

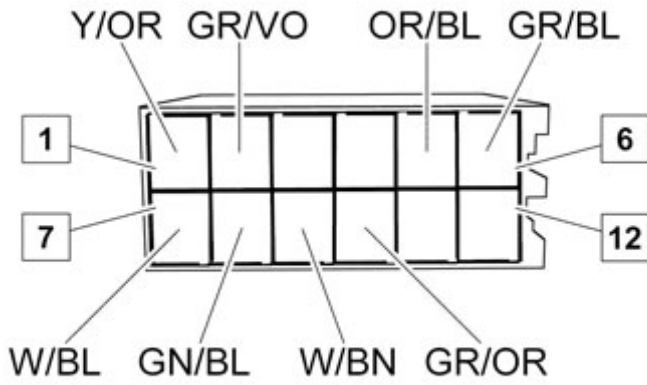

IMG-361342

All vehicles

94

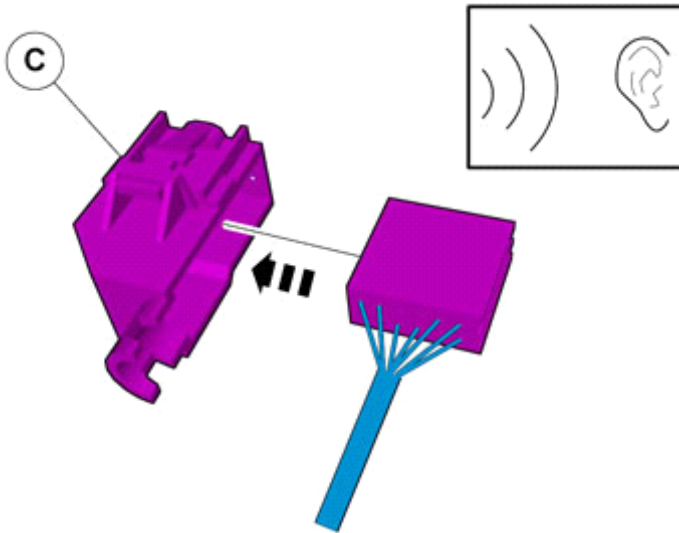

IMG-361376



Installation instructions, accessories

Volvo Car Corporation Gothenburg, Sweden

95

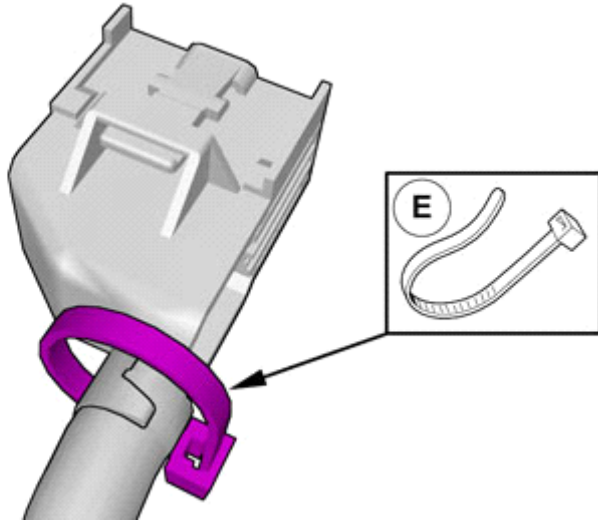

IMG-361377

96

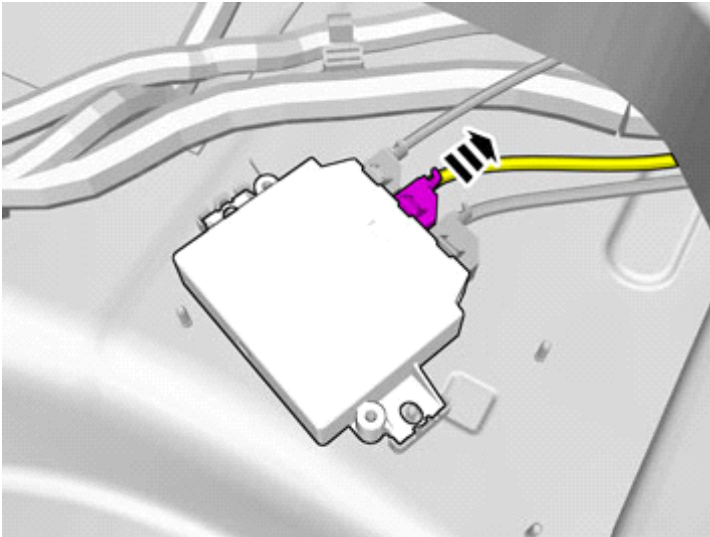

IMG-378052

Disconnect the connector, if applicable.

Attach the connector to the wiring harness.

Use: , Electrical tape

The connector is not to be used.

97

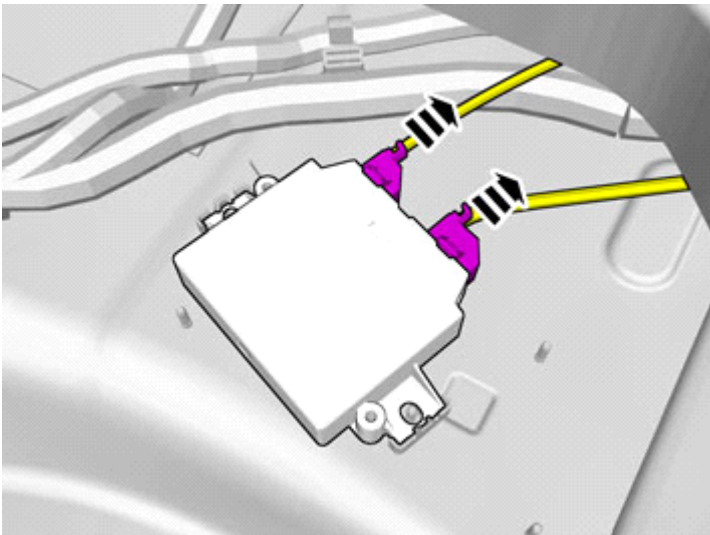

IMG-378055

Disconnect the connectors.



Installation instructions, accessories

Volvo Car Corporation Gothenburg, Sweden

98

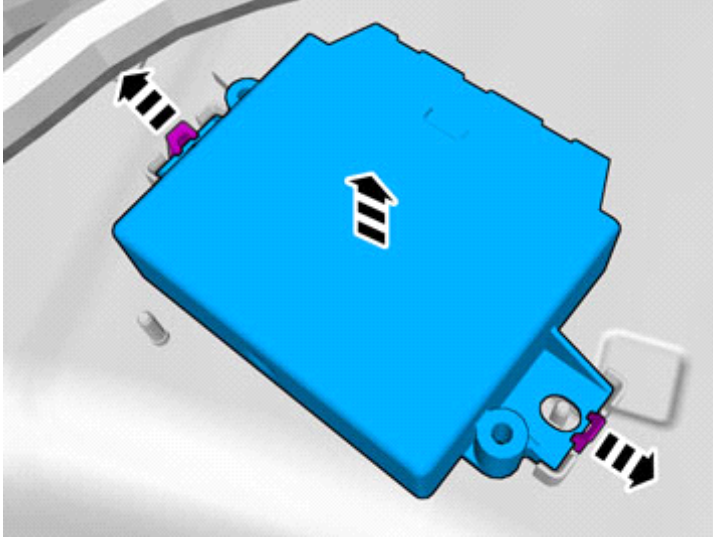

IMG-378062

The part is not to be reused.

99

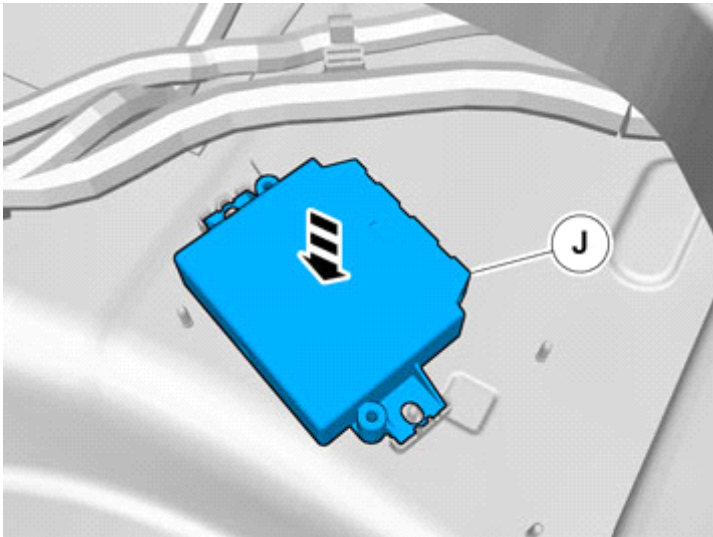

IMG-378063

Install component that comes with the accessory kit.

100

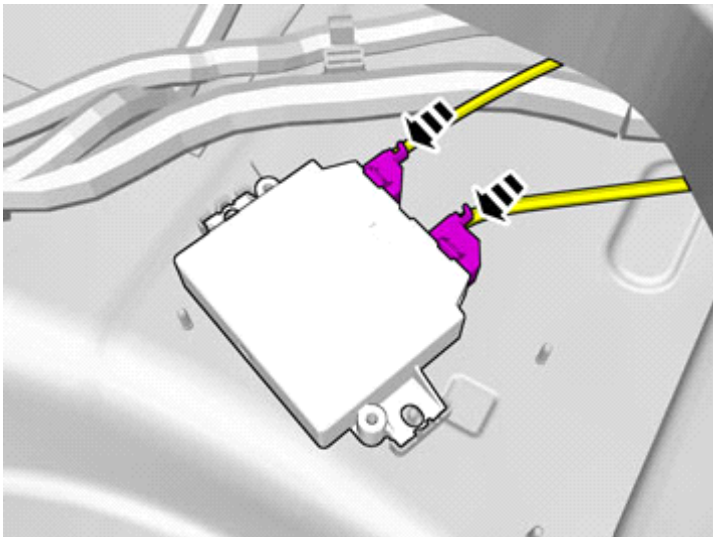

IMG-378065

Connect the connectors.



Installation instructions, accessories

Volvo Car Corporation Gothenburg, Sweden

101

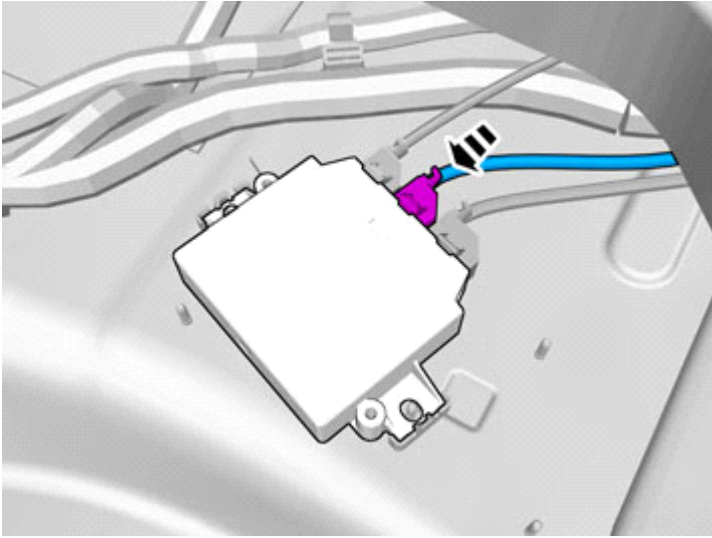

IMG-378066

Connect the prerouted cable.

102

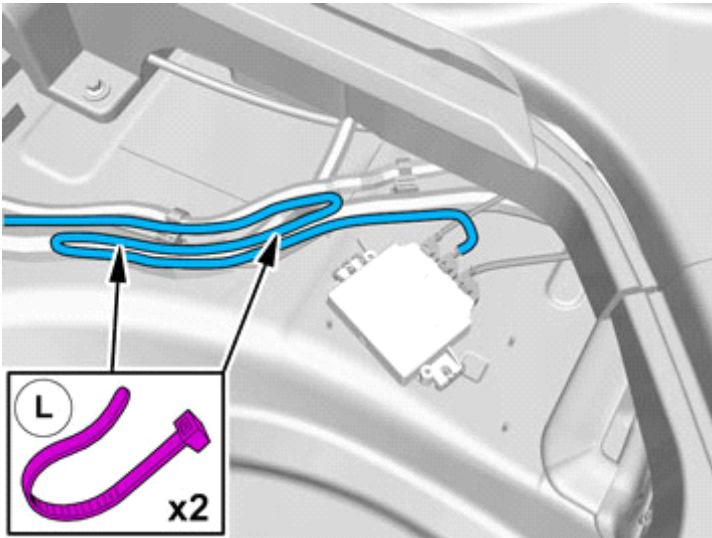

IMG-378070

Note!

Extra cable length must be secured using cable ties.



Installation instructions, accessories

Volvo Car Corporation Gothenburg, Sweden

103

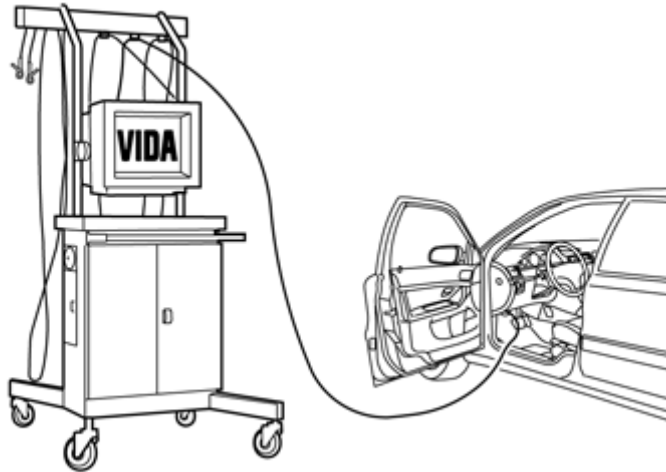

IMG-242268

Download software (application) for the accessory's function according to the service information in VIDA.

Order and download software according to: 31266964

104

Reinstall the removed parts in reverse order.

IMG-377070